

AIRCRAFT DESIGN AND SYSTEMS GROUP (AERO)

Innovative Aircraft Design – Options for a New Medium Range Aircraft

Dieter Scholz Hamburg University of Applied Sciences

**Presentation for DGLR / RAeS / VDI / PSL in
Hamburg Aerospace Lecture Series
at Hamburg University of Applied Sciences
25.06.2015**

<https://doi.org/10.5281/zenodo.22468>



Legal Stuff

Copyright © Dieter Scholz

The work is licensed under a **Creative Commons** Attribution-NonCommercial-ShareAlike 4.0 International License:
CC BY-NC-SA (<http://creativecommons.org/licenses/by-nc-sa/4.0>)

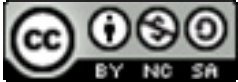

Refer to this work with (https://wiki.creativecommons.org/wiki/Best_practices_for_attribution):

Title: Innovative Aircraft Design - Options for a New Medium Range Aircraft

Author: Dieter Scholz (link to: <http://www.ProfScholz.de>)

Source: <https://doi.org/10.5281/zenodo.22468> (link can be placed under title)

License: CC BY-NC-SA 4.0 (link to: <http://creativecommons.org/licenses/by-nc-sa/4.0>)

Any further request may be directed to:

Prof. Dr.-Ing. Dieter Scholz, MSME

E-Mail see: <http://www.ProfScholz.de>

Download this file from:

<http://hamburg.dglr.de> or <http://www.raes-hamburg.de> or <https://zenodo.org/collection/user-dglr-hh>

Abstract

Task was to find an innovative aircraft design for a new medium range aircraft. The aircraft design methodology is based on equations (in contrast to numeric methods) and formal optimization with a genetic algorithm called differential evolution. Airbus has postponed an all-new A320 to 2025 or even 2030. This allows including also unconventional configurations into the search. Economic requirements are extreme: 25 % to 40 % reduction in fuel consumption, 35 % reduction in Cash Operating Costs. To achieve this, all aircraft design parameters have to be open for discussion. An aircraft called "The Rebel" is prepared to go to extreme parameters: low cruise speed, high wing span and long take-off and landing distance. Without new technologies it achieves 36 % reduced fuel consumption. The "Smart Turboprop" stays in conventional limits with its parameters, but makes use of a braced wing with natural laminar flow. It also achieves 36 % reduced fuel consumption plus a 17 % reduction in Direct Operating Costs (DOC). In addition, several Box Wing Aircraft were designed: Diamond Box Wing and Biplane Box Wing as Wide Body and alternatively as Slender Body. The Biplane Box Wing shows overall advantages due to its conventional tail. The details of Box Wing Aircraft design were mastered, but the Direct Operating Costs of the Box Wing Aircraft turned out to be higher than those of the A320 reference. This leaves the "Smart Turboprop" as the proposed configuration for an Airbus A320 replacement. As a short term measure, it is proposed to offer a horizontal wing tip extension as an option for the A320neo instead of the winglets. An extension with the same length as the winglet height offers far greater drag reduction. Airports will tolerate and accommodate some aircraft with a wing span above the ICAO limit in Class C of 36 m.

Content

- **Project Background**
- **Requirements**
 - **For Economics**
 - **At Airports**
- **Range of Investigation for a New A320 (NSR, A30X)**
 - **Pure Optimization "The Rebel"**
 - **"Smart Turboprop" (!)**
 - **"Box Wing Aircraft" (BWA)**
- **Summary**

Project Background



The research project was part of the

- Leading-Edge Cluster Competition of the Federal Ministry of Education and Research
 - Aviation Cluster Hamburg Metropolitan Region
 - Lighthouse Project 3: Airport 2030
 - Work Package 4: **Aircraft Configurations** for **Efficient Ground Operations**
 - Work Task 4.1: **Evolutionary** Aircraft Configurations "**Possible A320 Successor**"



Duration: 1st December 2008 - 31st January 2014 = **5 years** and 2 month

Employees and Students



Philip Krammer



Daniel Schiktanz



Andreas Johanning
PhD Candidate at



Tahir Sousa



Ricardo Caja Calleja



Priyanka Barua



Mihaela Niță



Liana Urseanu

Students with Thesis or Project

Tim von Ahlen
Sameer Ahmed
Nishant Bhanot
Jonne Bobis
Jeremy Bouten
Leon Dib
Karim Drews
Martin Fekete
Elena García Llorente
Steffen Hausenberg
Fahad Aman Khan
Hoa Ly
Hartwig Ottermann
Veselin Pavlov
Aday Pérez Reyes
Maria Pester
Karunanidhi Ramachandran
Haider Riaz
Luis Salord Losantos
Víctor Julián Sánchez Barreda
Daniel Schiktanz
Roberto Segovia García
Elien Verheire
Jeroen Verstraete
Maarten Waeterschoot

Student Assistants

Patrick Carter
Alain Chahine
Andreas Johanning
Matthias Koppe
Daniel Marciano
Mahmud Mir
James Murray
Dennis Paape
Maria Pester
Daniel Schiktanz

"Evolutionary" not "Revolutionary"

Estimation of maximum glide ratio $E = L/D$ in normal cruise

A : aspect ratio

S_{wet} : wetted area

S_W : reference area of the wing

e : Oswald factor; passenger transports: $e \approx 0.85$

from statistics: $k_E = 15,8$

S_{wet} / S_W :	conv. aircraft	6.0 ... 6.2
	BWB	≈ 2.4

$$E_{max} = k_E \sqrt{\frac{A}{S_{wet} / S_W}}$$

$$k_E = \frac{1}{2} \sqrt{\frac{\pi e}{c_f}} = 14.9$$

$$\overline{c_f} = 0.003$$

"Evolutionary" not "Revolutionary"

Not suitable for a "Possible A320 Successor":

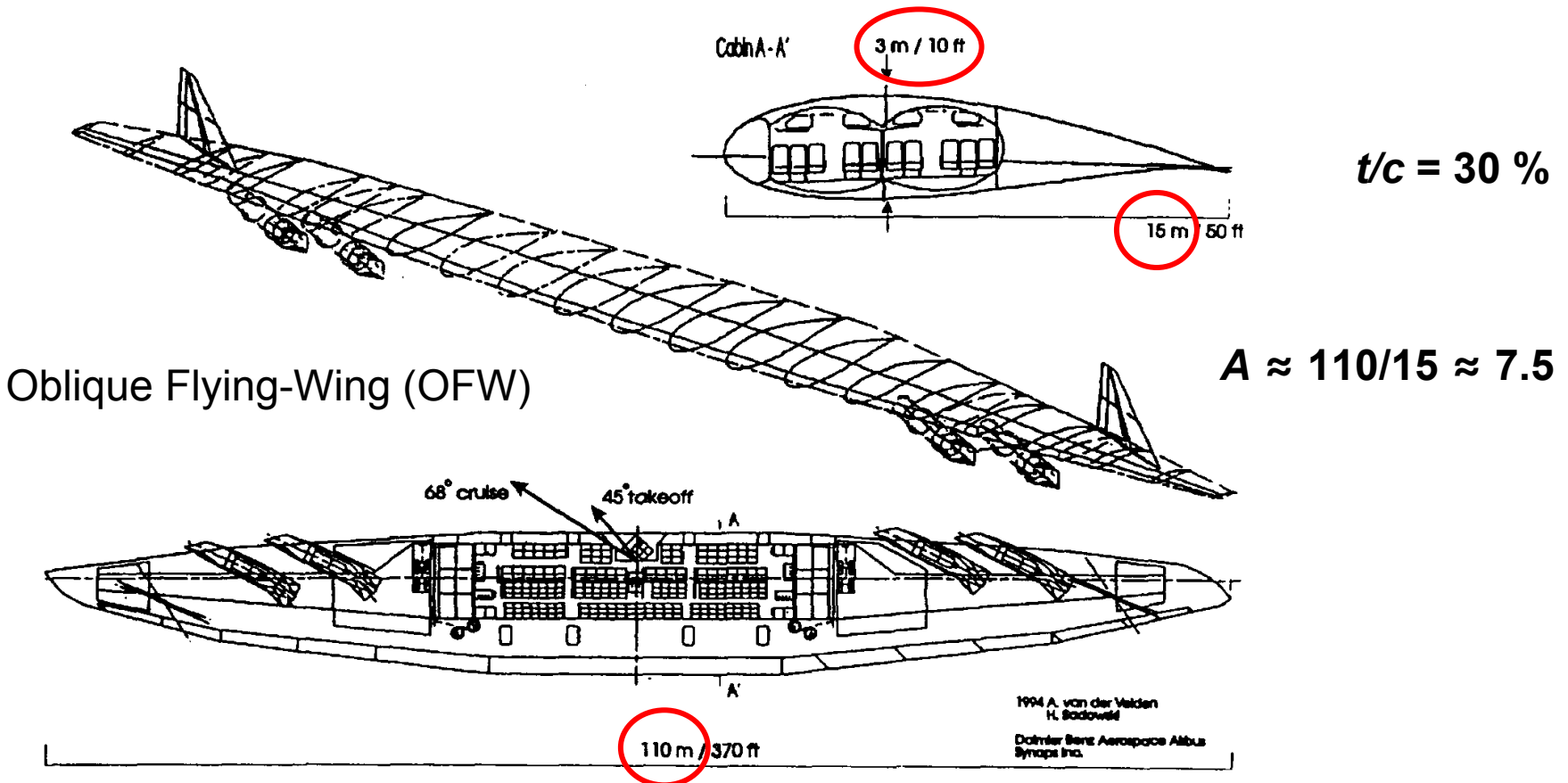

"Evolutionary" not "Revolutionary"

Not suitable for a "Possible A320 Successor":

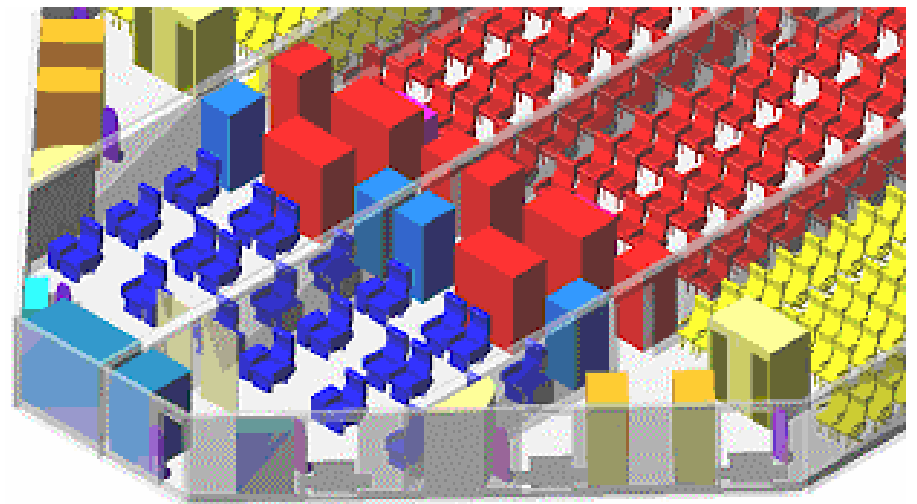
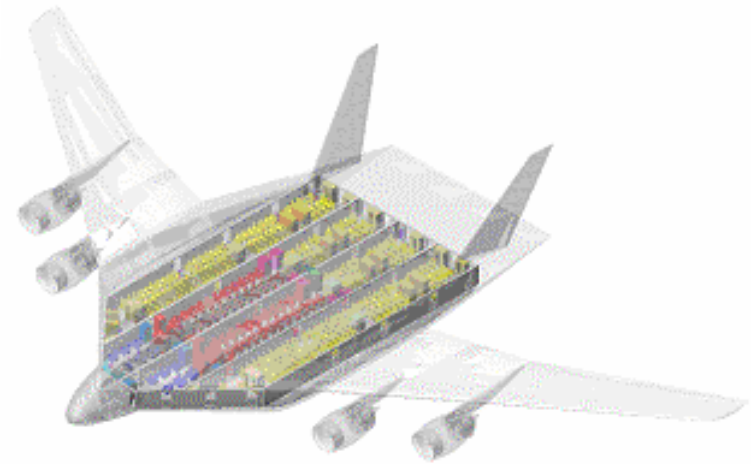
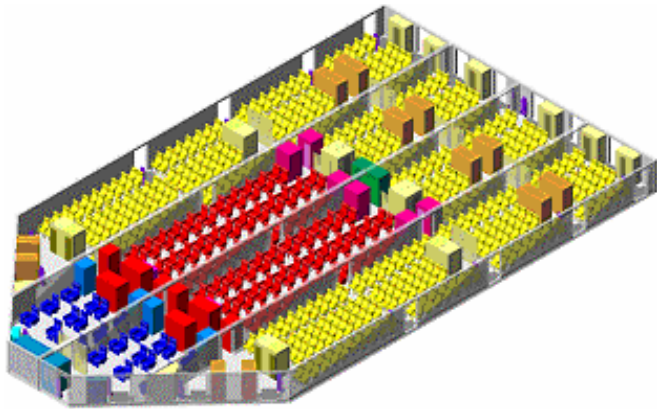

"Evolutionary" not "Revolutionary"

Square-Cube-Law =>

The BWB configuration is favoured for ultra large aircraft.

Why does physics demand a BWB?

$$S_W \propto l^3$$

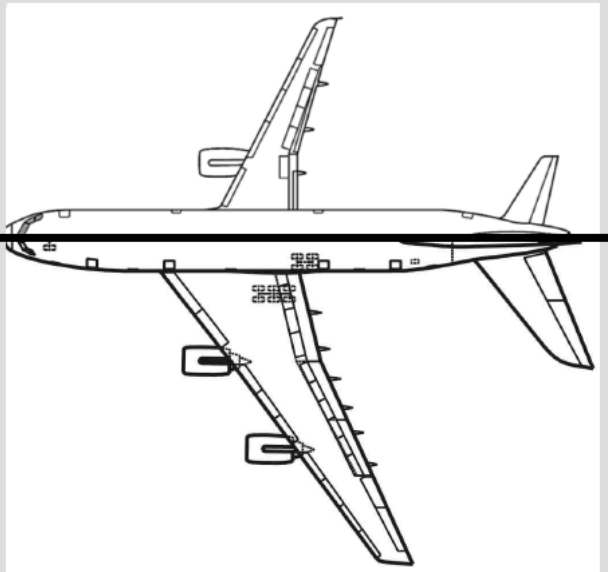

A321 scaled to the same size
as the A380.

A321: $\frac{m_{MTO}}{S_W} = 727 \text{ kg/m}^2$

A380-800F: $\frac{m_{MTO}}{S_W} = 698 \text{ kg/m}^2$

Aircraft even bigger => BWB

Suitable for a
"Possible A320
Successor":

Let's split the wing
to double effective
aspect ratio, $A = b^2/S$



=> a **box wing aircraft!**

Ideas from the Web ...



Lockheed



Bauhaus Luftfahrt



Lockheed

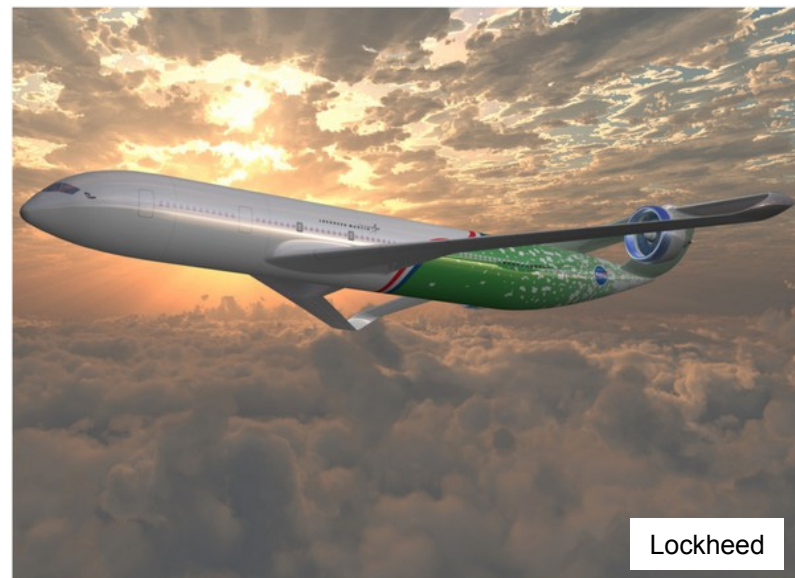

Lockheed

Ideas from the Web ...

2.5 liters / pax / 100 Km

TECHNOLOGY, PROFITABILITY
AND ECO-EFFICIENCY

CAN TECHNOLOGY, PROFITABILITY
AND ECO-EFFICIENCY GO TOGETHER?

ATR aircraft offers the lowest greenhouse gas emissions, best technical solutions, and unique commonality while remaining the most cost efficient technology. Now, say Yes to ATR aircraft and choose the best solution for short haul flights.

Designed for economics, 40% less on fuel bills
Reduced ecological footprint: **2.5 liters** / pax / 100 Km (or 100 miles per gallon per pax)
The only ETOPS 120-min turboprop

PROFITABILITY
ENVIRONMENT
TECHNOLOGY

ATR
An Alenia Aeronautica and EADS joint venture
PROPELLING TOMORROW'S WORLD

www.atraircraft.com

More Ideas from the Web ...



	m	MTO	M	CR	P _{eq}	Pax
A320		78 t	0,76		xxx	180
A400M		141 t	0,70		4 x 8250 kW	xxx
ATR 72		23 t	0,46		2 x 1950 kW	72
Q400		29 t	0,60		2 x 3780 kW	78
Smart TP		56 t	0,51		2 x 5000 kW	180

Aircraft Take Shape ...

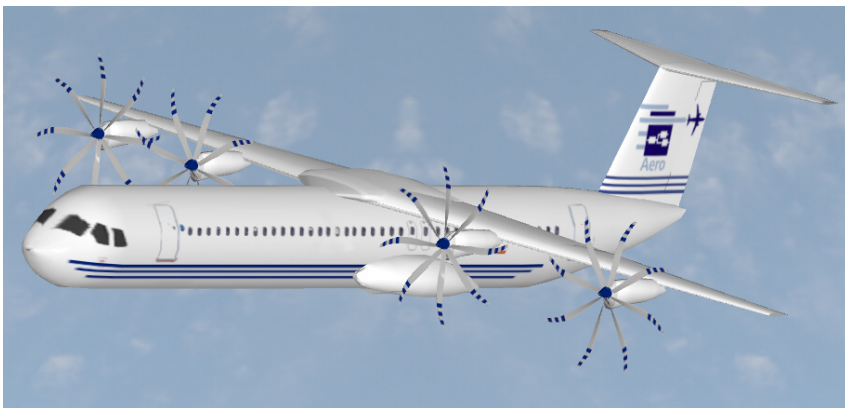
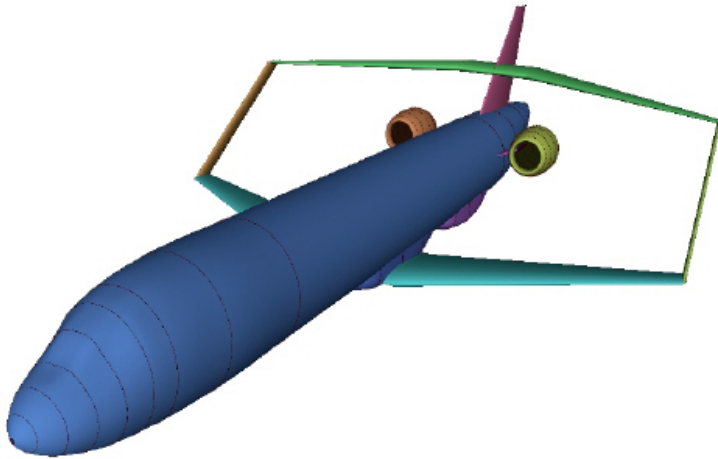

At the end of the project: Something to touch ...



... and to fly ...



Watch videos on <https://goo.gl/vj2Hq6>

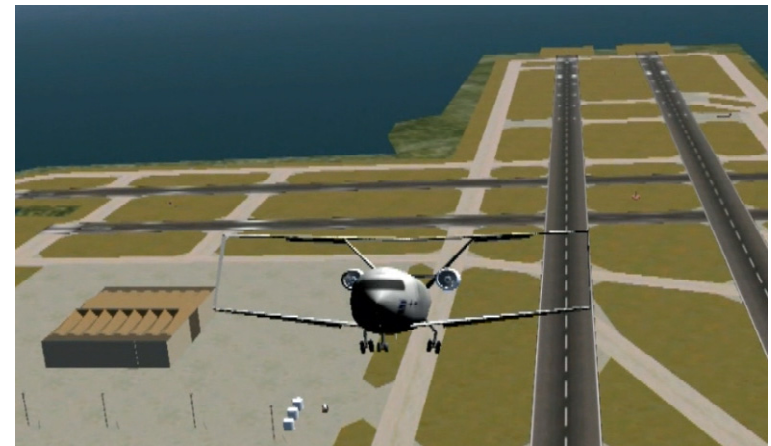

... and it gets reported:

FLIGHT
INTERNATIONAL

FG Flightglobal
AVIATION CONNECTED

RESEARCH DAVID KAMINSKI-MORROW LONDON

Study backs 'smart turboprop' design

Researchers looking to increase medium-haul aircraft efficiency favour an advanced turbo-prop over box-wing concepts.

In co-operation with Airbus, Hamburg University of Applied Sciences embarked on a study to explore a possible successor to the A320, as part of a project known as Airport 2030.

As well as an optimised conventional jet configuration, the study examines various box-wing designs, as well as the option of a turboprop. The team aims to consider high-efficiency aircraft designs which would avoid changing ground infrastructure.

The project involves studying families of single- and twin-aisle

box-winged aircraft of 126-218 seats. However, while box-wing concepts offer a reduction in drag, this economic advantage is countered by the increased weight of the wing.

The direct operating costs of box-wing models are calculated to be some 20% higher than those of the A320.

However, the "smart turboprop" design's economics prove more promising, the study says, with a 17% lower operating cost and a 36% cut in fuel burn.

This is based on a twin-engined aircraft with a high wing braced by struts, and a T-tail configuration featuring technologies including laminar flow. ■



The project aims to explore a possible successor to the A320

14 | **Flight International** | 2-8 September 2014

flightglobal.com

<http://www.flightglobal.com/news/articles/-smart-turboprop-favoured-by-future-design-study-402952>

What else in the News?

FLIGHT

PROPULSION JOHN CROFT WASHINGTON DC

05/2011:

90-seat turboprop beckons to P&WC

Engine manufacturer to begin assembling next-generation powerplant to prepare for possible creation of bigger airframes

AIRFRAMES MAVIS TOH SINGAPORE

01/2013:

ATR keen to satisfy 90-seat audience

Turboprop manufacturer yet to convince shareholders despite Asian regional carriers' interest in potential larger aircraft

ANALYSIS MURDO MORRISON LONDON

01/2013:

ATR ascends as Bombardier suffers

Growing demand from lessors helps Franco-Italian airframer beat Canadian rival in turboprop orders and deliveries race

01/2013:

WHO WILL LAUNCH AN ALL-NEW 90-SEAT TURBOPROP?

The chances are, nobody will – but pressure from airline customers might conjure up a 2013 launch of a product that regional aircraft makers agree will eventually be a necessity.

01/2011:

DEVELOPMENT DAVID KAMINSKI-MORROW TOULOUSE

Demand for big turboprops will grow, says ATR

Airframer seeks 'convergent' solution with engine manufacturers to develop future 90-seat models

"I'm insisting on one point. The priority is cost-effectiveness, not spending money on speed"

FILIPPO BAGNATO
Chief executive, ATR

What else in the News?

FLIGHT

03/2014:

TURBOPROPS

Airbus Group keen on 90-seat ATR, but in no rush to launch

01/2015:

TURBOPROPS MURDO MORRISON PARIS

Can ATR cope with success?

After its best-ever year, French manufacturer faces challenges of ramp-up, maintaining sales and future product direction

05/2015:

DEVELOPMENT

DAVID KAMINSKI-MORROW LONDON MURDO MORRISON TOULOUSE

Market needs put 90-seater plan at bottom of ATR list

Resistance from Airbus Group contributes to retreat from larger model as production capacity continues to increase

Meanwhile at Airbus internally

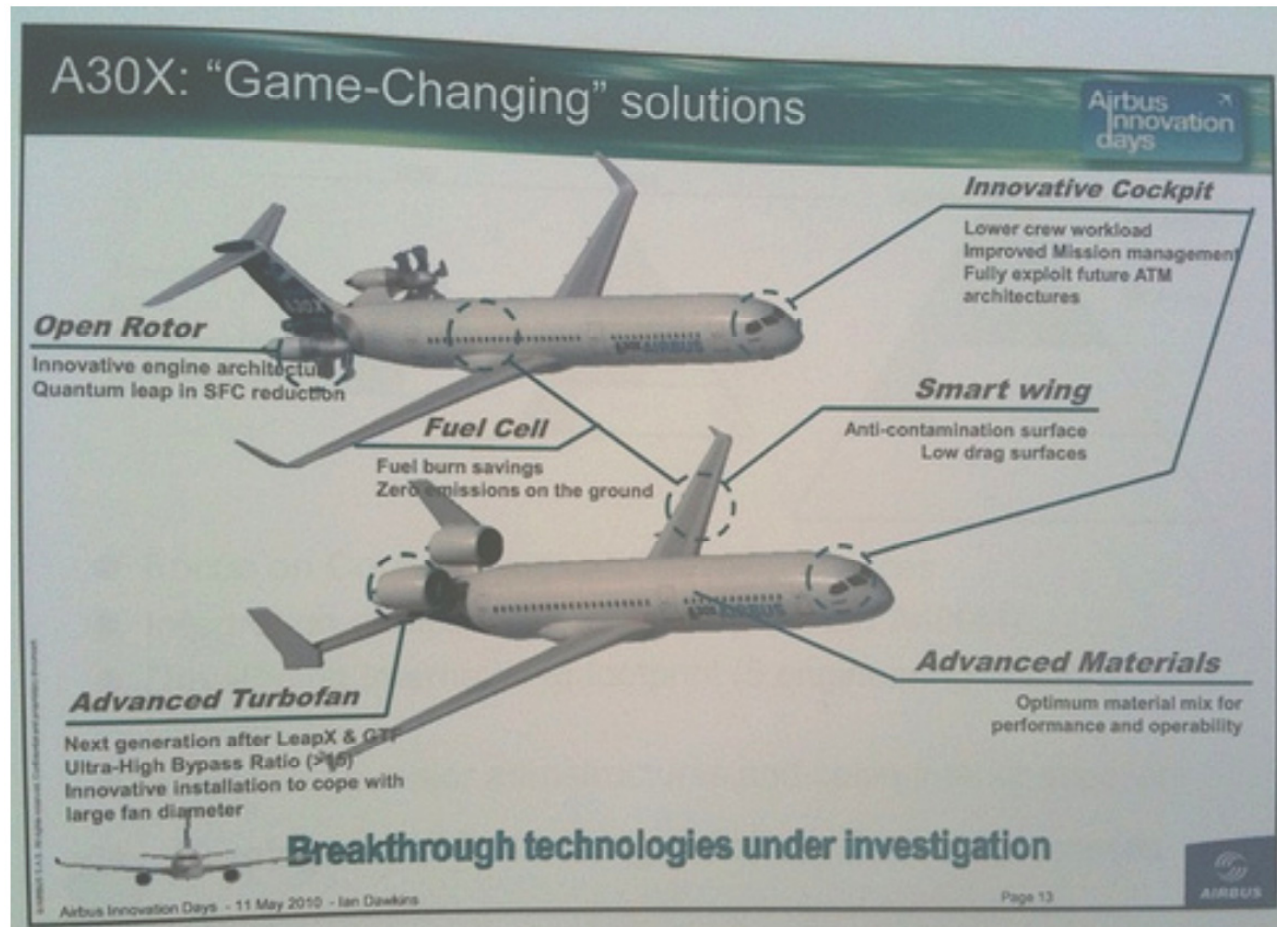

Jon Ostrower on May 11, 2010. http://www.flightglobal.com/blogs/flightblogger/2010/05/airbus_outlined_future_a30x_co

What else in the News?



A fuel-efficient engine option for Airbus' A320 Family

On 4/2011 uploaded to https://youtu.be/K5FH_PraQQZQ

“We’re not redesigning the A320. It’s pretty damn good just the way it is,” **John Leahy**, Airbus’s chief commercial officer, says in a promotional video touting the A320neo’s fuel efficiency. He says the company doesn’t believe new technologies being researched will be ready before the mid-2020s. That’s when Airbus is likely to contemplate an all-new design to replace the A320 family. [1]

Bloomberg 05/2014

At Airbus any all-new single aisle aircraft is unlikely to be constructed before 2025.

01/2010:

Airbus sees lifespan of at least 10 years for re-engined A320

FLIGHT

Ground Handling (to be considered in Airport2030)

- **Example: Continuous Cargo Compartment**

- Time saving: No repositioning of loader
- Cargo handling is not on critical path for gate positions
- Slight time advantage only in few cases (e.g. two door oper. on apron)
- Same costs

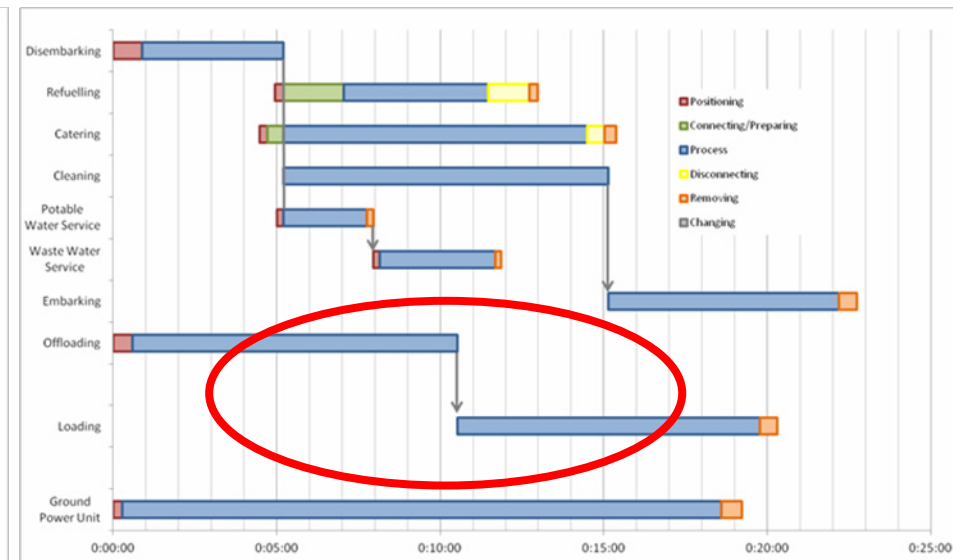
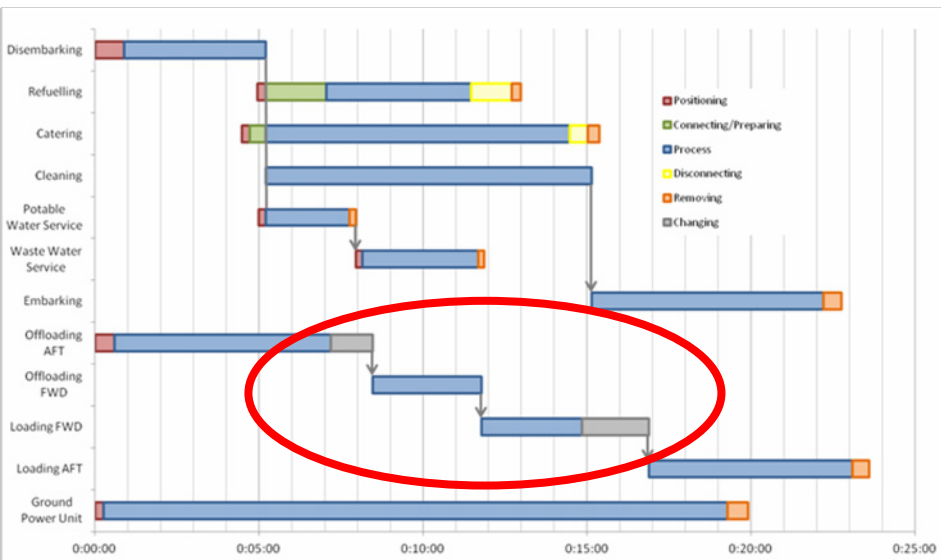
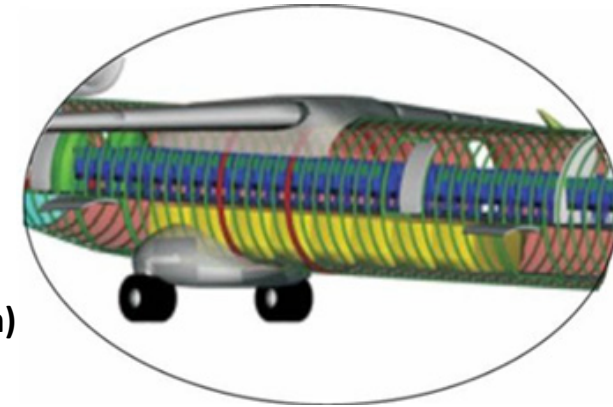

Ground Handling (to be considered in Airport2030)

- **Example: Continuous Cargo Compartment**

- Time saving: No repositioning of loader
- Cargo handling is not on critical path for gate positions
- Slight time advantage only in few cases (e.g. two door operation on apron)
- Same costs

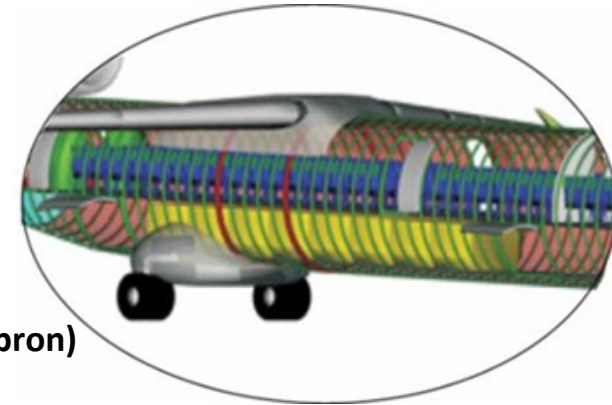

- **Most evaluated technologies with advantages on the ground impair the DOC of the aircraft**

- Twin-aisle
- Increase of aisle width
- Foldable seat (if seat is heavier)

- **Ground handling processes need to be robust to avoid delays!**

Aircraft need to be optimized for cruise!

Economic Top Level Requirements

Airbus/DLR Design Challenge for 2013 (M. Fokken, Airbus):

- Fuel burn: **minus 25%** versus an A320 with 190 instead of 180 pax
- CoC: **minus 35%** versus an A320 with 190 instead of 180 pax

SNECMA (Aviation Week & Space Technology, 2014-03-31) [2]:

“Buyers of next-generation short/medium-range airliners will expect big steps in aircraft economics, at least a **40-percent fuel-burn-per-passenger improvement**,” says Vincent Garnier, Snecma vice president of marketing strategy for civil engines.

Requirements at Airports ...

... are Driving Today's Aircraft Design! [3]

Annex 14 — Aerodromes

Volume I

ICAO

Table 1-1. Aerodrome reference code
(see 1.6.2 to 1.6.4)

Code number (1)	Code element 1		Code element 2		
	Aeroplane reference field length (2)	Code letter (3)	Wing span (4)	Outer main gear wheel span ^a (5)	
1	Less than 800 m	A	Up to but not including 15 m	Up to but not including 4.5 m	
2	800 m up to but not including 1 200 m	B	15 m up to but not including 24 m	4.5 m up to but not including 6 m	
3	1 200 m up to but not including 1 800 m	C	24 m up to but not including 36 m	6 m up to but not including 9 m	
4	1 800 m and over	D	36 m up to but not including 52 m	9 m up to but not including 14 m	
		E	52 m up to but not including 65 m	9 m up to but not including 14 m	
		F	65 m up to but not including 80 m	14 m up to but not including 16 m	

a. Distance between the outside edges of the main gear wheels.

Range of Investigation for a New A320

- **Standard Jet Configuration**
"The Rebel"
- **Standard Prop Configuration**
"Smart Turboprop"
- **Non-Standard Jet Configuration**
"Box Wing Aircraft" (BWA)
 - Wide Body / Slender Body
 - Diamond BWA / Biplane BWA

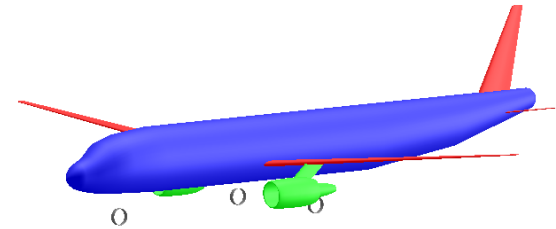

Genetic algorithm (Differential Evolution) proposes parameters. Aircraft „designed“ automatically in EXCEL. **Optimization** for **minimum DOC**. About 2000 feasible designs tested in one run.

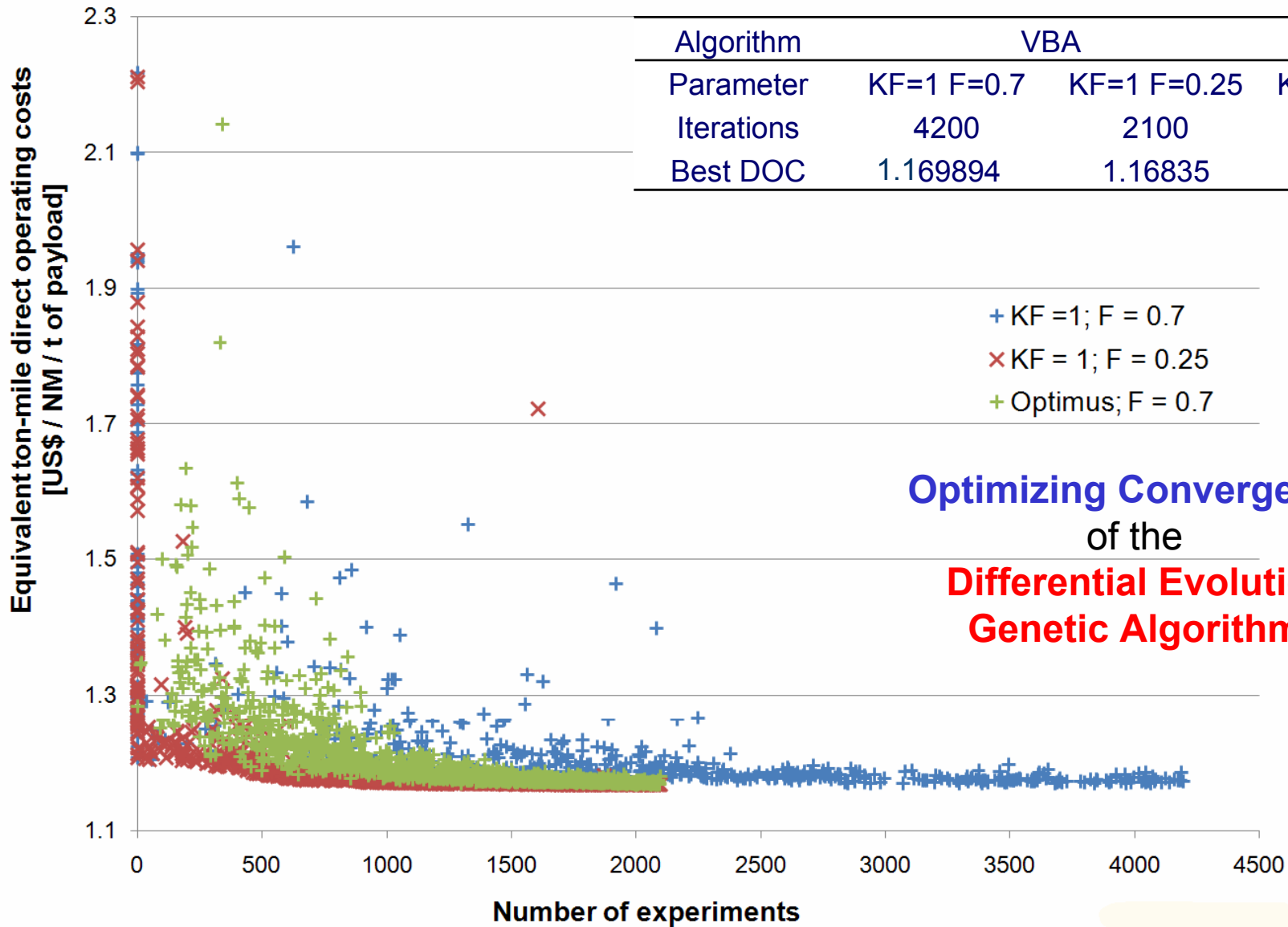

Standard Jet Configuration: "The Rebel"

- Conventional Jet Configuration ... but ...
- Questioning established requirements. This results in:
 - wing span: $b > 36$ m
 - take-off and landing distance: $S_{TOFL} > 1800$ m
 - cruise Mach number:

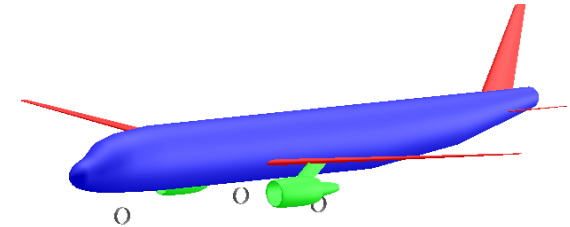

$$M_{CR} < 0.76$$

Code element 1		Code element 2		
Code number (1)	Aeroplane reference field length (2)	Code letter (3)	Wingspan (4)	Outer main gear wheel span ^a (5)
1	Less than 800 m	A	Up to but not including 15 m	Up to but not including 4.5 m
2	800 m up to but not including 1 200 m	B	15 m up to but not including 24 m	4.5 m up to but not including 6 m
3	1 200 m up to but not including 1 800 m	C	24 m up to but not including 36 m	6 m up to but not including 9 m
4	1 800 m and over	D	36 m up to but not including 52 m	9 m up to but not including 14 m

- Considering alternative objective function
 - DOC (standard), DOC + Added Values
 - Minimum fuel

[3] ICAO: Aerodromes, Volume I – Aerodrome Design and Operations, Annex 14 to the Convention on International Civil Aviation, 5th edition, 2009

Standard Jet Configuration: "The Rebel"

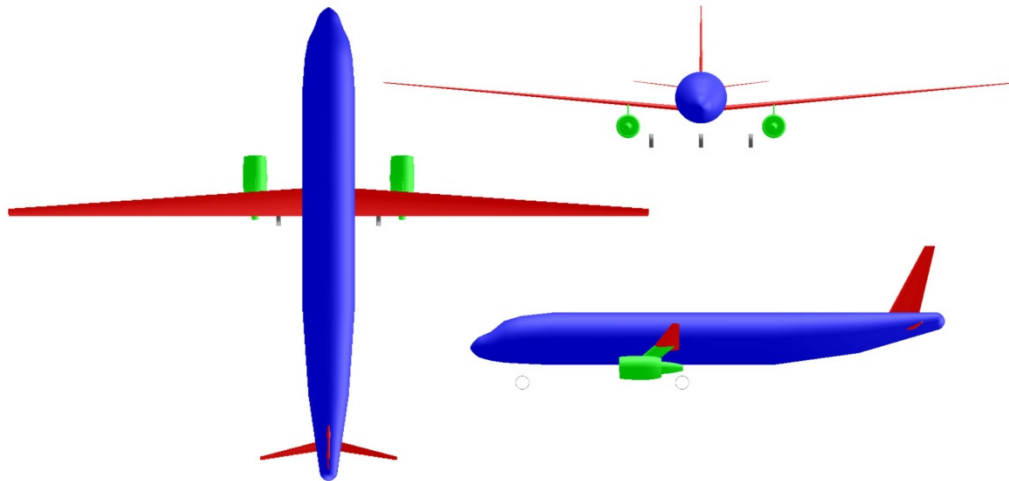

Early conceptual design

Parameter	Value	Deviation from A320*
Requirements		
m_{MPL}	19256 kg	0 %
R_{MPL}	1510 NM	0 %
M_{CR}	0.55	- 28 %
$\max(s_{TOFL}, s_{LFL})$	2700 m	+ 53 %
n_{PAX} (1-cl HD)	180	0 %
m_{PAX}	93 kg	0 %
SP	28 in	- 3 %

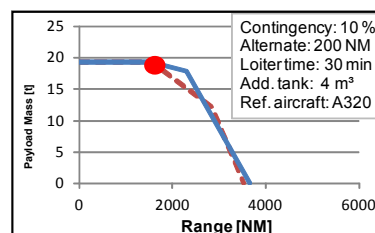
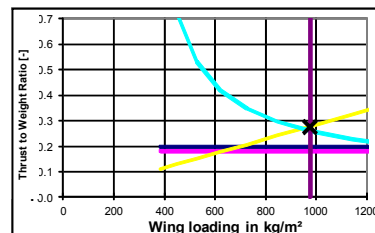

Parameter	Value	Deviation from A320*
Main aircraft parameters		
m_{MTO}	66000 kg	- 10 %
m_{OE}	39200 kg	- 5 %
m_F	7500 kg	- 42 %
S_W	68 m ²	- 45 %
$b_{W,geo}$	48.5 m	+ 42 %
$A_{W,eff}$	34.8	+ 266 %
E_{max}	26.1	+ 48 %
T_{TO}	89100 N	- 20 %
BPR	15.5	+ 158 %
SFC	1.03E-5 kg/N/s	- 37 %
h_{ICA}	30000 ft	- 23 %
s_{TOFL}	2490 m	+ 41 %
s_{LFL}	2110 m	+ 45 %
t_{TA}	32 min	0 %

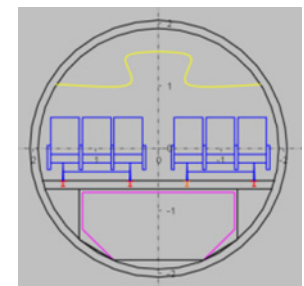

Standard Jet Configuration: "The Rebel"

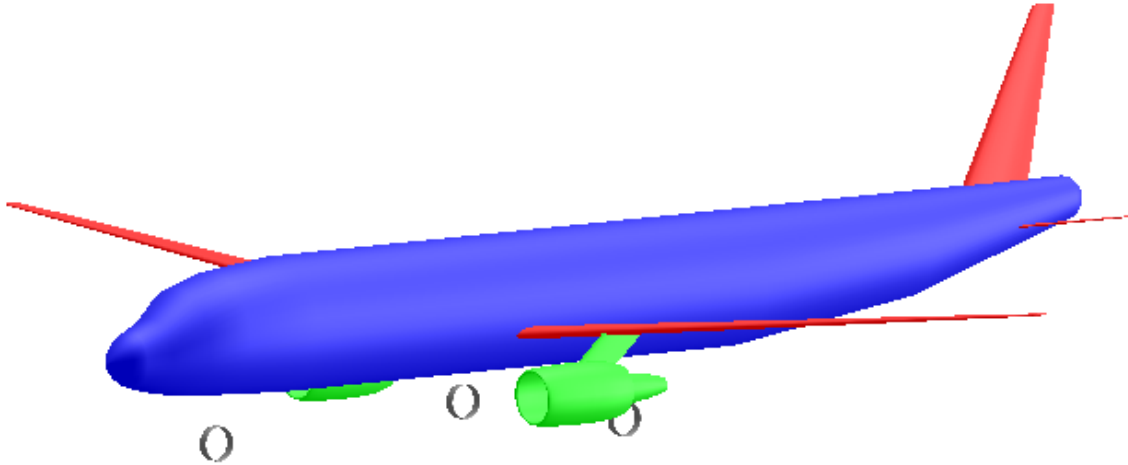

Parameter	Value	Deviation from A320*
DOC mission requirements		
R_{DOC}	750 NM	0 %
$m_{PL,DOC}$	19256 kg	0 %
EIS	2030	-----
c_{fuel}	1.44 USD/kg	0 %
Results		
$m_{F,trip}$	3700	- 36 %
$U_{a,f}$	3070	+ 6 %
DOC (AEA)	93 %	- 7 %

Operating empty mass breakdown

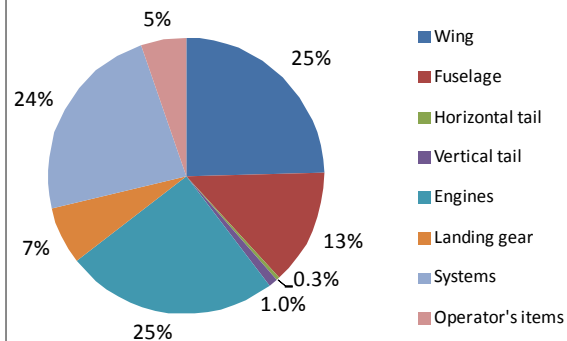

Component drag breakdown

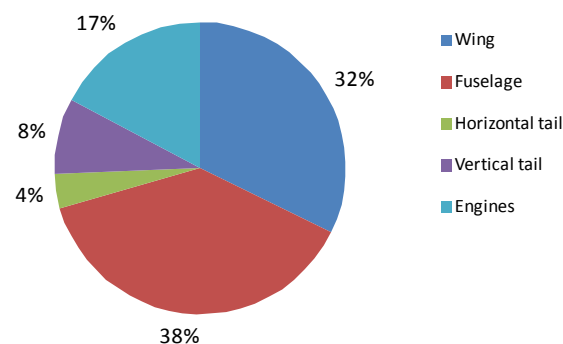

Direct operating cost breakdown

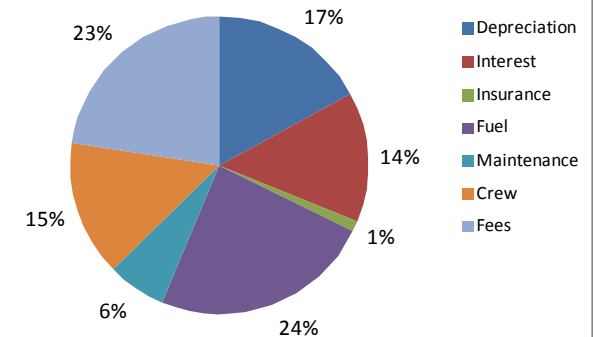

Proposal: Horizontal Wing Tip Extension on A320neo as Option

- Wingtip devices: Very **limited efficiency** compared to the same length of material used to horizontally extend the wing [4]

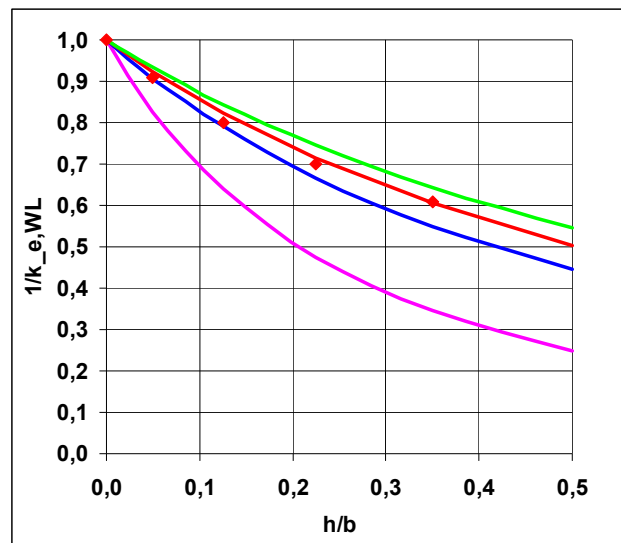

$$k_{e,WL} = \left(1 + \frac{2}{k_{WL}} \frac{h}{b} \right)^2 = \frac{A_{eff}}{A} = \left(\frac{b_{eff}}{b} \right)^2$$

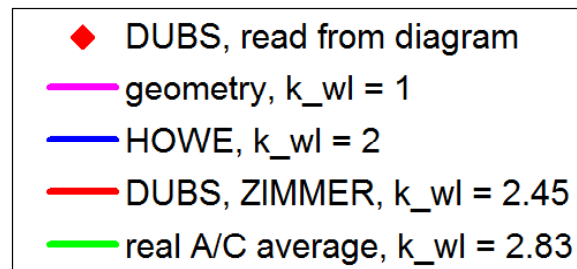

- Results from an *additional study* [5] in Airport2030:
“Airport Compatibility of Medium Range Aircraft with Large Wing Span”

- Consider this option: Extend the wing span and **just deal with consequences** at airports!
- => Airbus should also offer a **horizontal** wing tip extension as option for A320neo.

Proposal: Horizontal Wing Tip Extension on A320neo as Option

- Optional horizontal wing tip extension **limits risk and costs compared to a new wing**
- A **slow introduction** of aircraft with larger wing span (Class C => Class D) will force airports to accept this
- **Landing fees** are based on MTOW and are hence **unchanged**
- Study [4] showed: Many **airports** still **have some capacity** for a limited number of former Class C aircraft now with larger span
- Airports will start to rearrange gate layout initially with **additional markings**

Standard Prop Configuration: "Smart Turboprop"

- **Turboprop** engine advantages:
 - Compared to turbofan engines: **More fuel efficient**
 - Compared to counter-rotating open rotor:
 - **Lower development risk**
 - **No added structural weight (500 kg [1]) to cater for rotor-burst shielding**
- Low flying → higher speed of sound → **similar speed** at lower Mach number
- Additional future technologies:
 - **Strut braced wing** (30% less wing mass; literature study)
 - **Natural laminar flow**
- All this together:

„Smart Turboprop“



Open-Rotor Disadvantages

Airbus, Snecma Tackle **Open-Rotor Integration**

March 31, 2014

Graham Warwick, Aviation Week & Space Technology [2]

...

Key to economic viability will be the weight penalty incurred to **protect the aircraft from damage caused by a rotor burst or blade release**. A turbofan can contain a released blade, but an open rotor will require shielding of the airframe and systems. In Airbus's baseline concept, which has pusher open-rotor **engines mounted on the aft fuselage** and a conventional T tail, shielding of the rear fuselage and tail **adds about 500 kg** to the aircraft's weight ...



Comments:

- In contrast: **Propeller blades are assumed not to release**. Nevertheless: ↑
- Mounting **engines on the aft fuselage** (c.g. shift ...) leads to overall **weight penalties**.

Low Flying – Similar Speed at Lower Mach Number

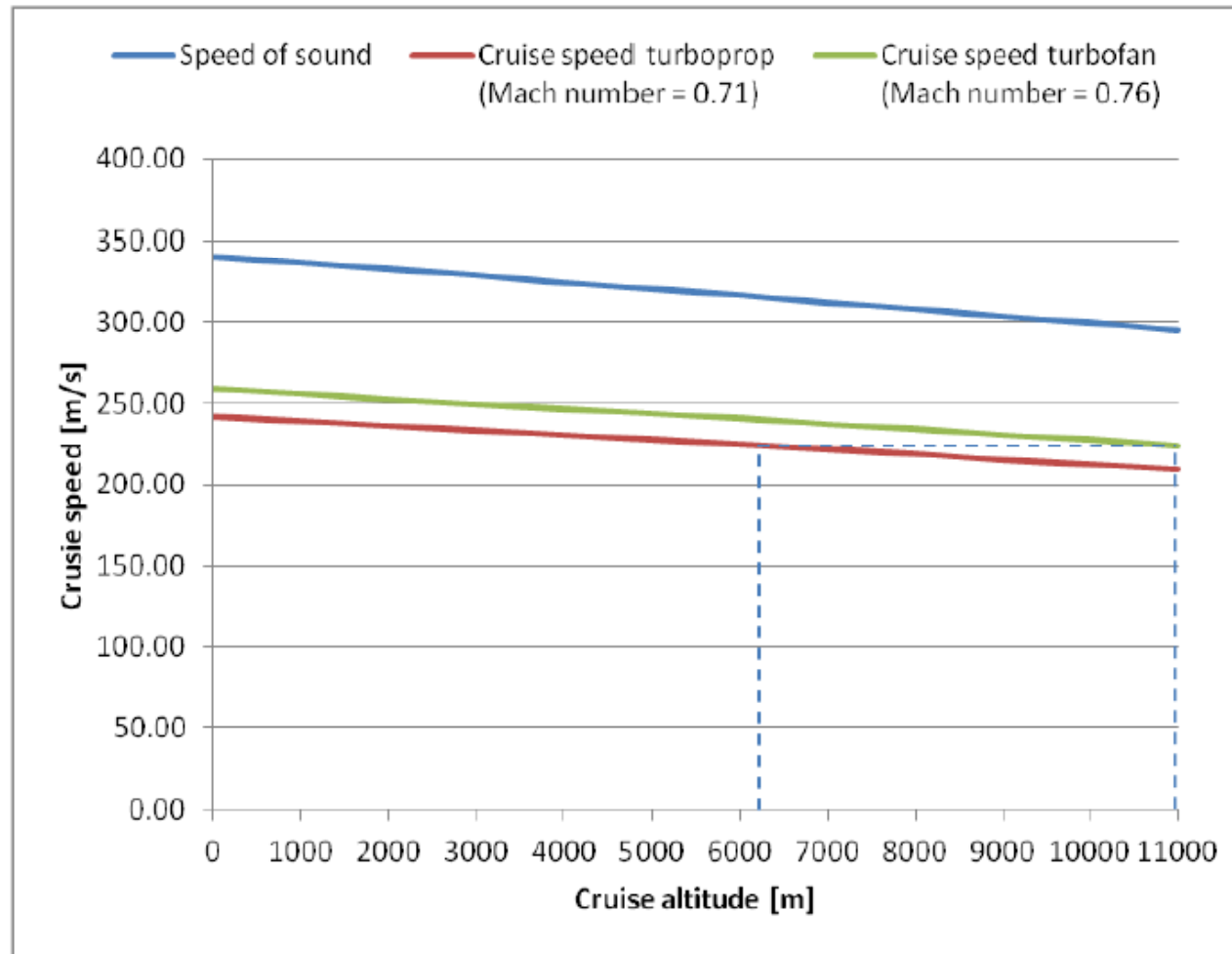

The „Speed Corner“

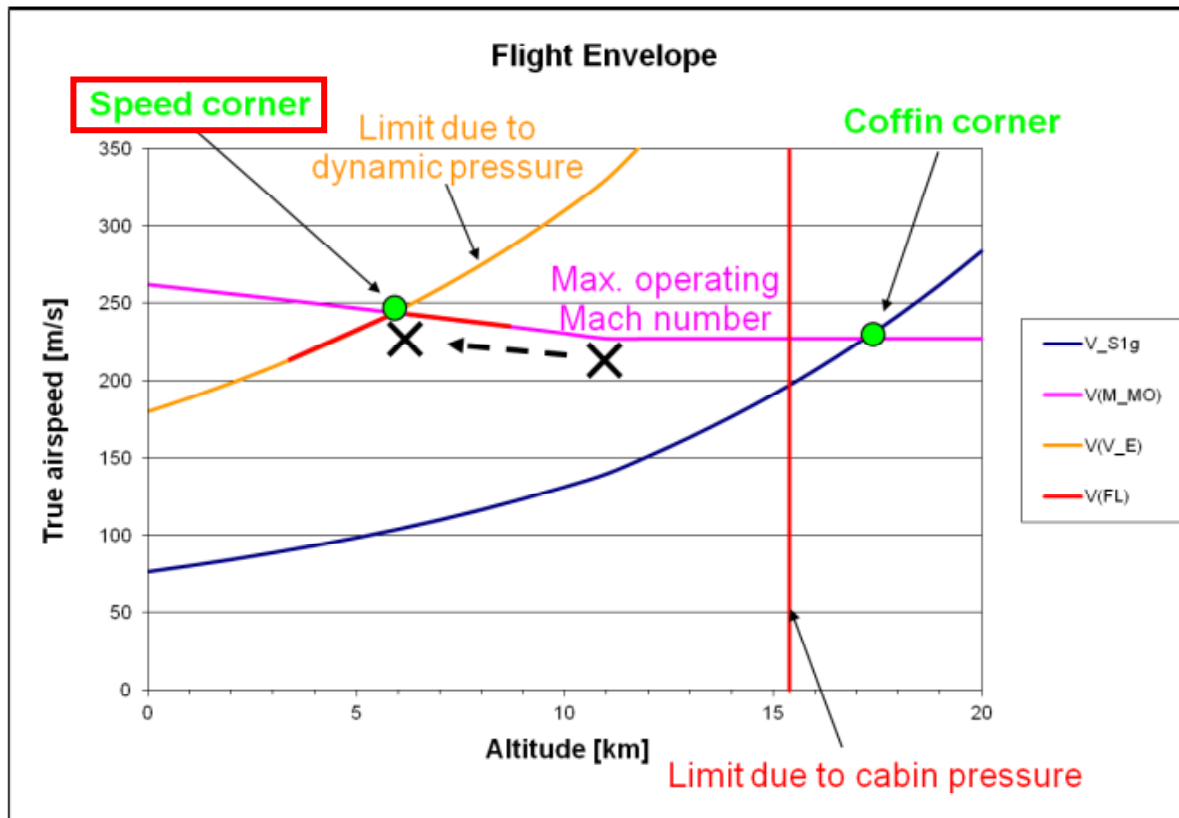

The altitude of the speed corner:

$$h_{SC} = \left(1 - \left(\frac{V_E}{M_{MO} \cdot a_0} \right)^{0.3805} \right) \cdot \frac{T_0}{L}$$

The true airspeed allowed in the speed corner:

$$V = M_{MO} a_0 \sqrt{1 - \frac{L h_{sc}}{T_0}}$$

Propeller Integration

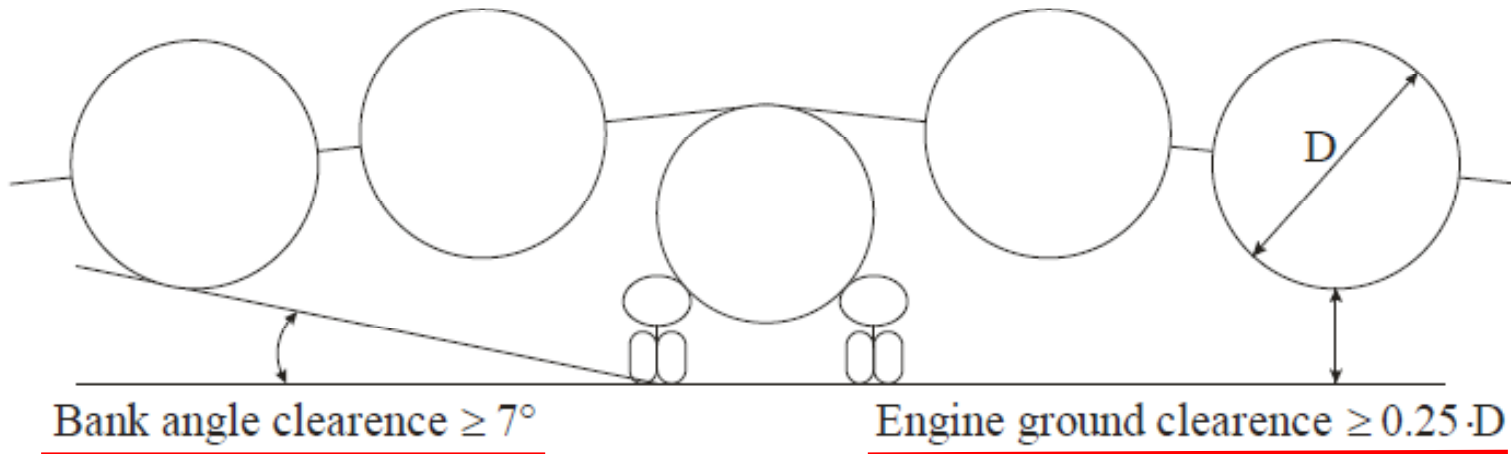

- Minimum propeller clearance from fuselage
- Minimum propeller clearance between propellers
- Propeller may not extend over wing tip

⇒ **Landing gear length and weight**

Natural Laminar Flow Representation

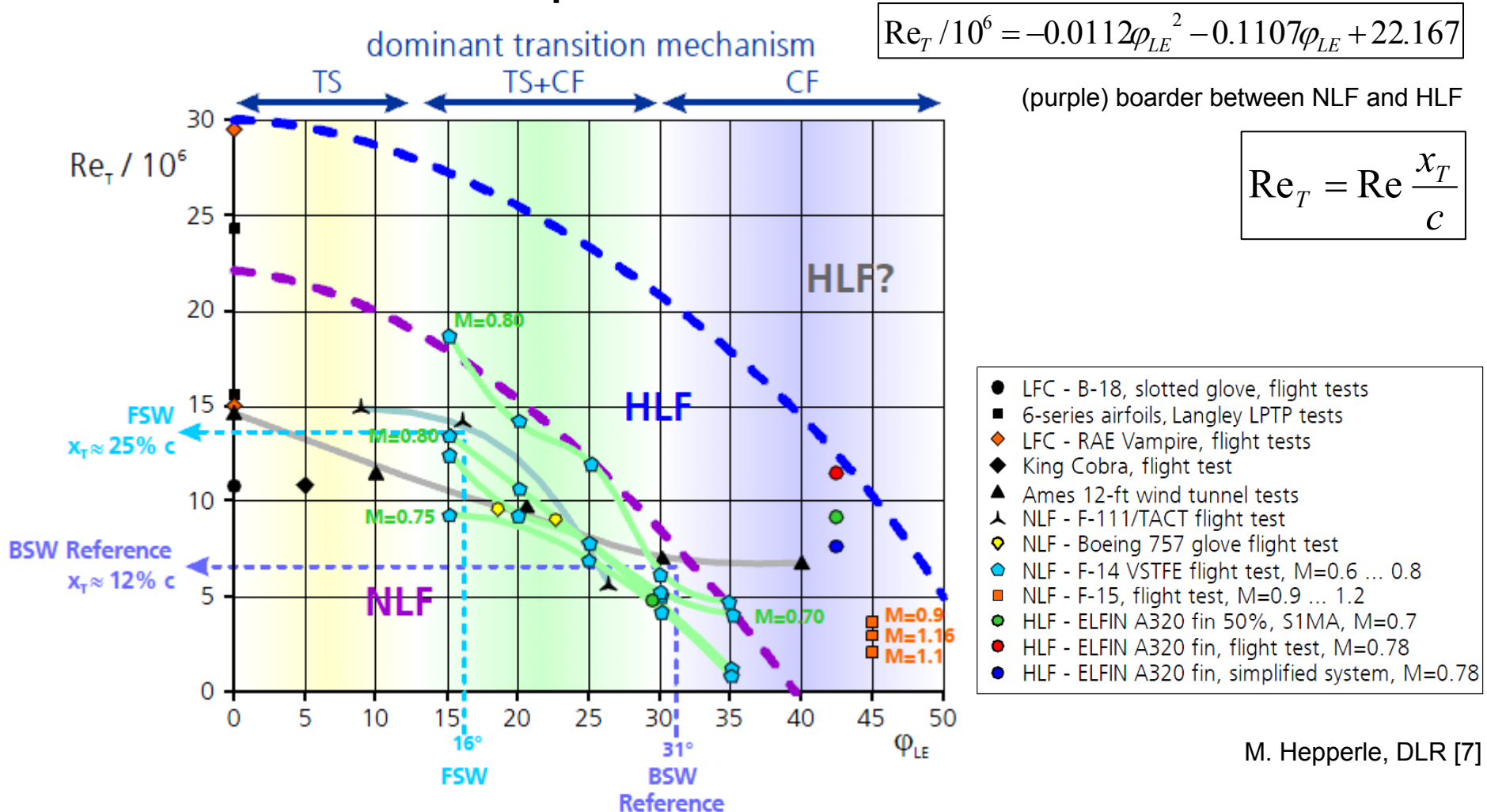

M. Hepperle, DLR [7]

Smart Turboprop: Results

- Choosing the optimum aircraft configuration:

Smart Turboprop **optimized for low DOC** compared to A320

Best config.

Turboprop w/o NLF/SBW	T-tail		Conventional tail	
	2 engines	4 engines	2 engines	4 engines
High wing	-13,6%	-11,4%	-13,3%	-11,1%
Low wing	-12,4%	-11,5%	-12,9%	-11,1%

- Wisdom from this optimization study:

- **2 engines better** than 4 engines
- For 2 engines: **High wing better** than low wing (0,4 ... 1,2 % PT)
- For 4 engines: Low wing as good as high wing
- NLF improves DOC by about 2,8 % PT
- Struts improve DOC by about 0,5 % PT
- NLF and Struts improve DOC by about 3 % PT

Standard Prop Configuration: "Smart Turboprop"

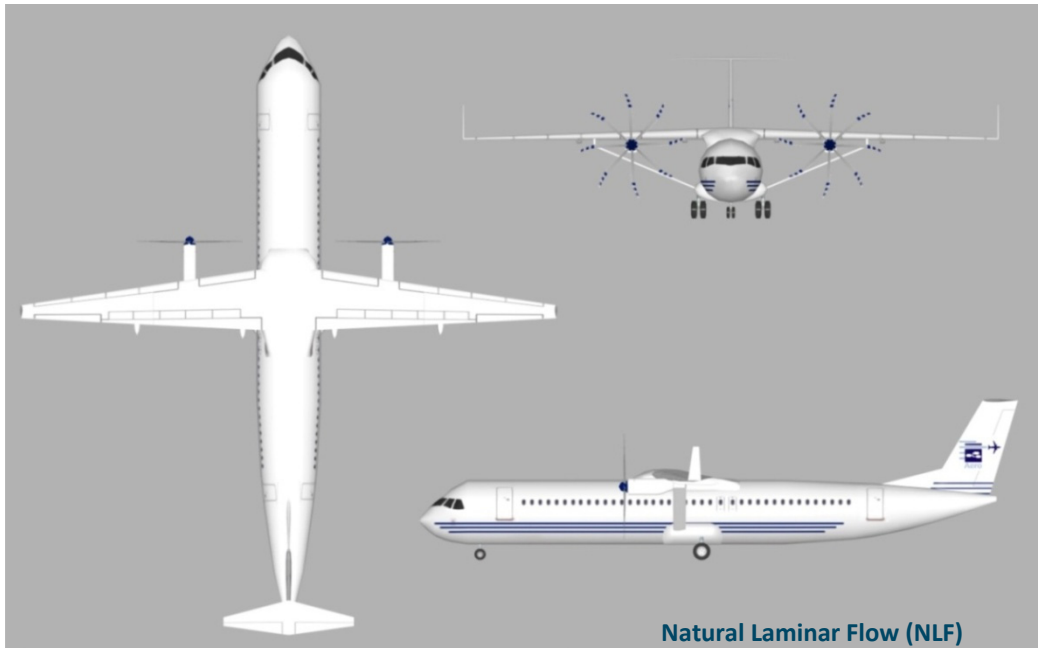

Parameter	Value	Deviation from A320*
Requirements		
m_{MPL}	19256 kg	0 %
R_{MPL}	1510 NM	0 %
M_{CR}	0.51	- 33 %
$\max(s_{TOFL}, s_{LFL})$	1770 m	0 %
n_{PAX} (1-cl HD)	180	0 %
m_{PAX}	93 kg	0 %
SP	29 in	0 %

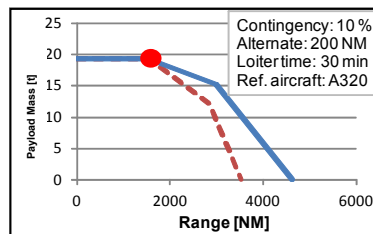
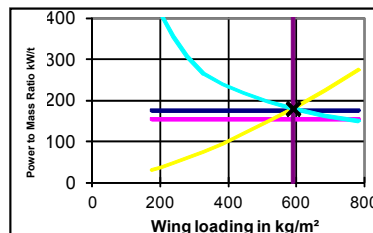

Parameter	Value	Deviation from A320*
Main aircraft parameters		
m_{MTO}	56000 kg	- 24 %
m_{OE}	28400 kg	- 31 %
m_F	8400 kg	- 36 %
S_W	95 m ²	- 23 %
$b_{W,geo}$	36.0 m	+ 6 %
$A_{W,eff}$	14.9	+ 57 %
E_{max}	18.8	\approx + 7 %
$P_{eq,ssl}$	5000 kW	-----
d_{prop}	7.0 m	-----
η_{prop}	89 %	-----
$PSFC$	5.86E-8 kg/W/s	-----
h_{ICA}	23000 ft	- 40 %
s_{TOFL}	1770 m	0 %
s_{LFL}	1300 m	- 10 %
t_{TA}	32 min	0 %

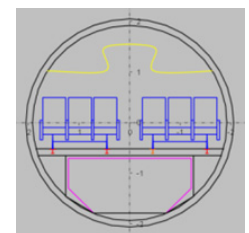

Standard Prop Configuration: "Smart Turboprop"



Parameter	Value	Deviation from A320*
DOC mission requirements		
R_{DOC}	755 NM	0 %
$m_{PL,DOC}$	19256 kg	0 %
EIS	2030	-----
c_{fuel}	1.44 USD/kg	0 %
Results		
$m_{F,trip}$	3700 kg	- 36 %
$U_{a,f}$	3600 h	+ 5 %
DOC (AEA)	83 %	- 17 %

Operating empty mass breakdown

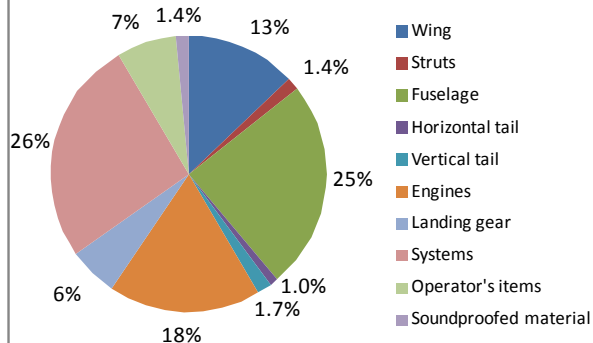

Component drag breakdown

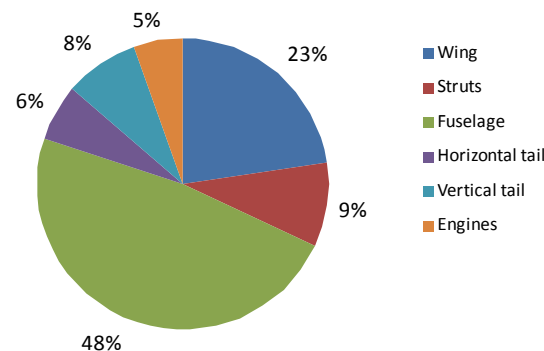

Direct operating cost breakdown

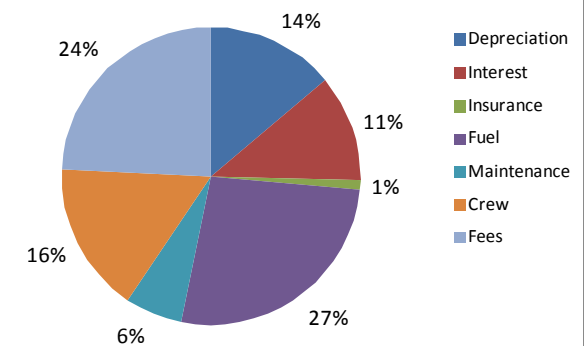



Smart Turboprop: Analysis of the Results

- In 1988, we would have preferred a turbofan aircraft as well

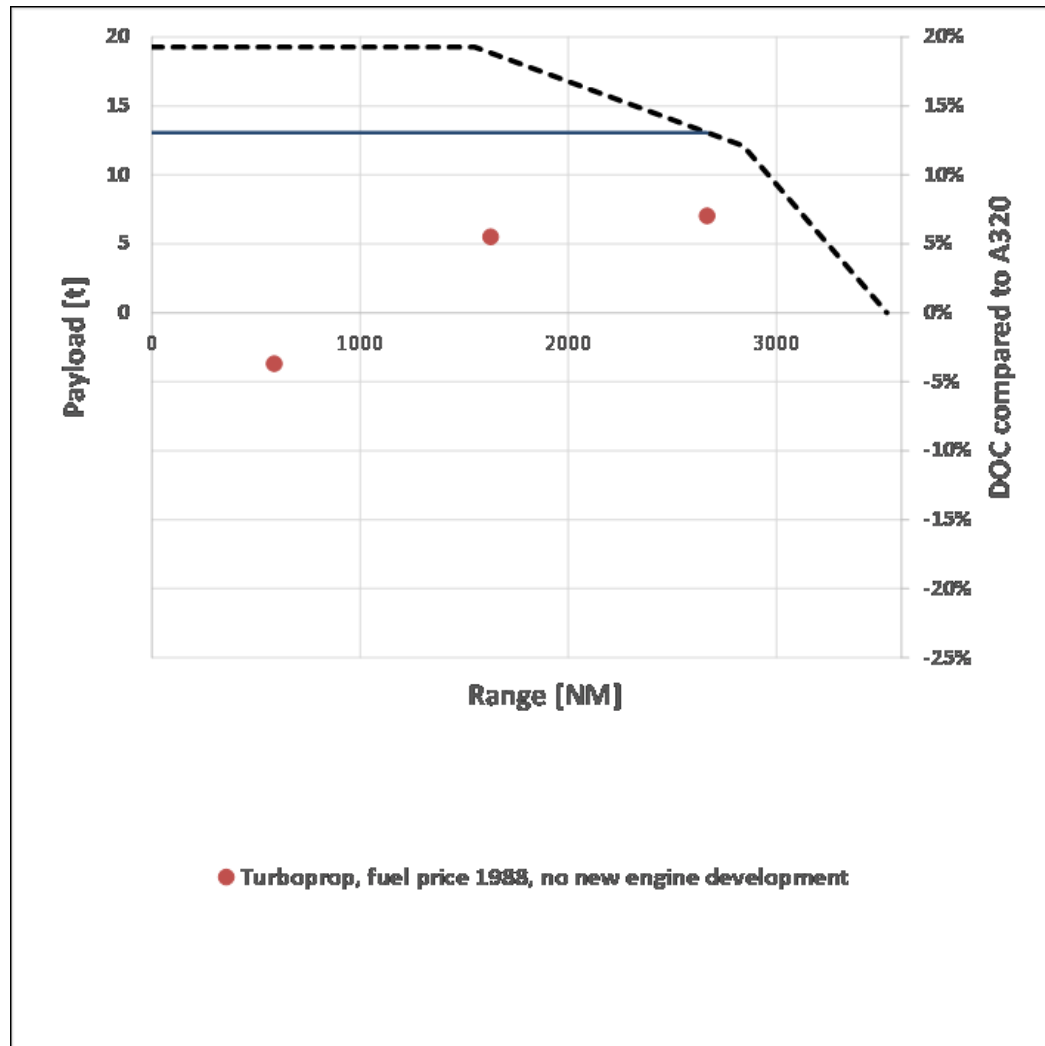

Smart Turboprop: Analysis of the Results

- Today, fuel price is four times as high as in 1988 (inflation-adjusted)!

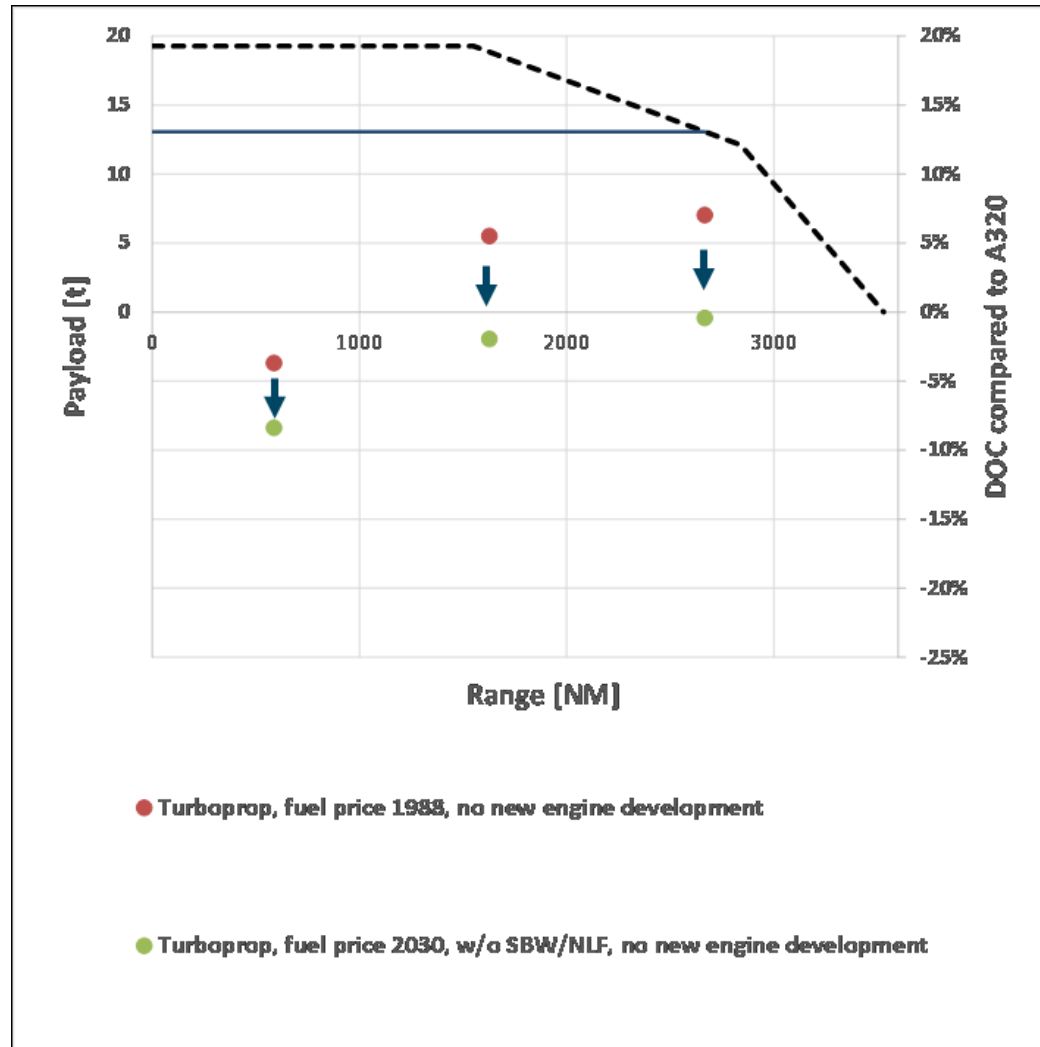

Smart Turboprop: Analysis of the Results

- For an A320 successor, a **next generation turboprop engine** could be used

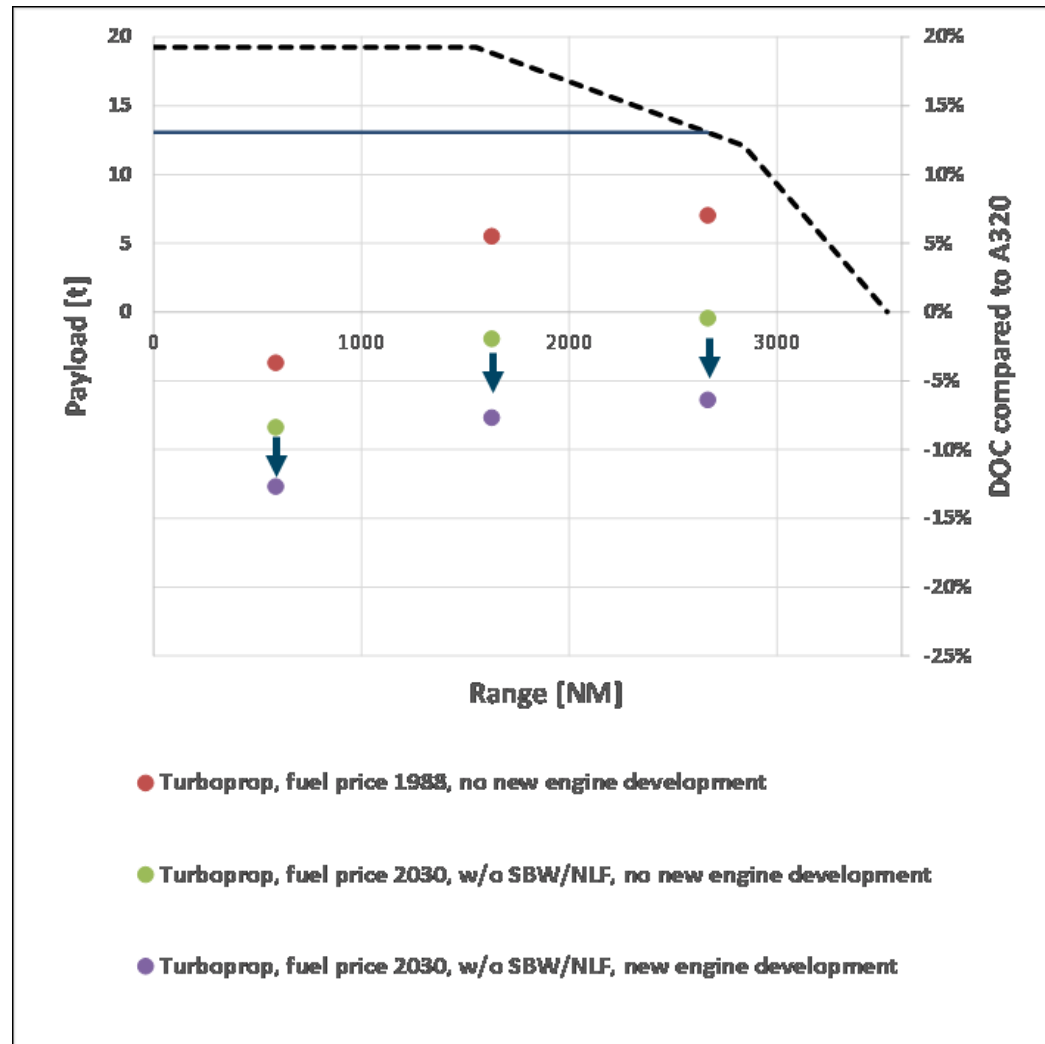

Smart Turboprop: Analysis of the Results

- **Strut-braced wing slightly improves DOC**

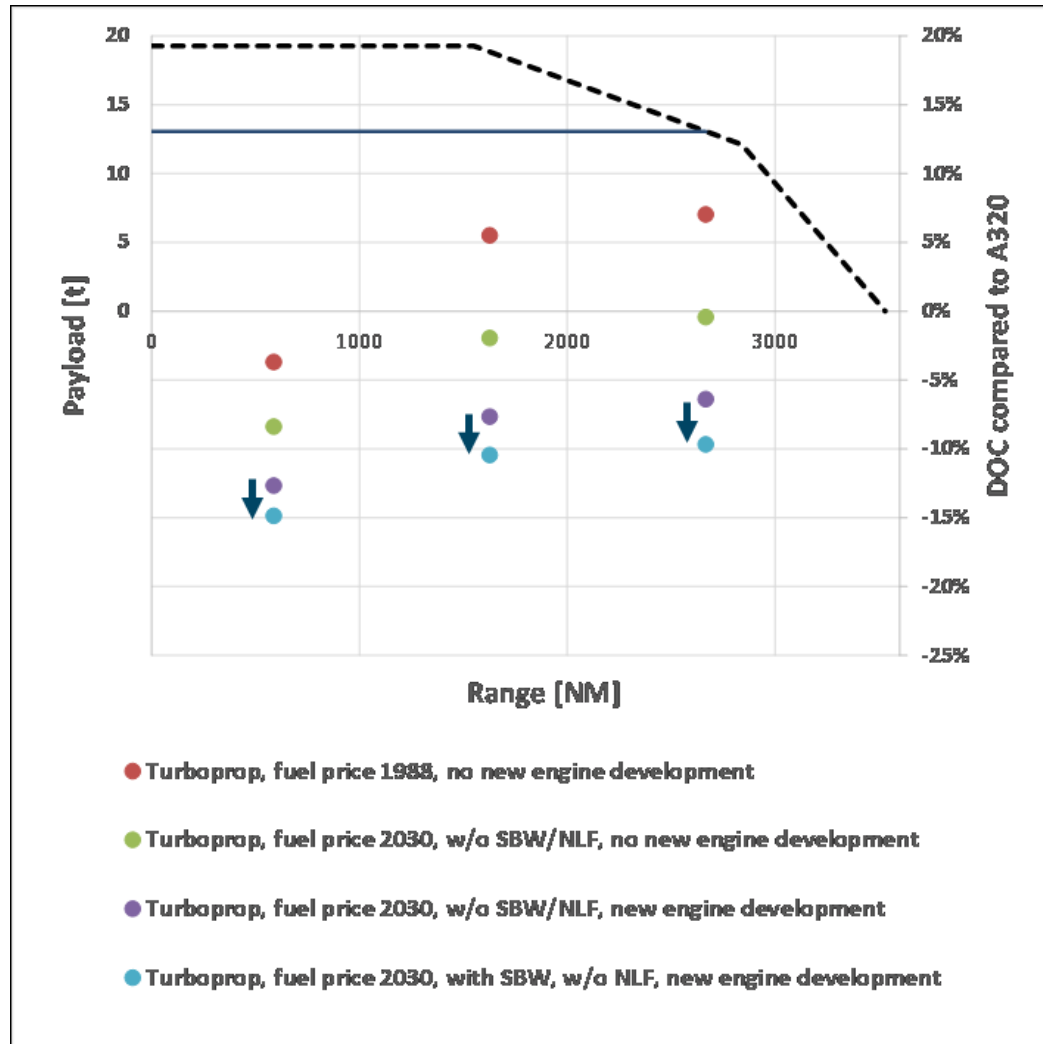

Smart Turboprop: Analysis of the Results

- Natural laminar flow slightly improves DOC

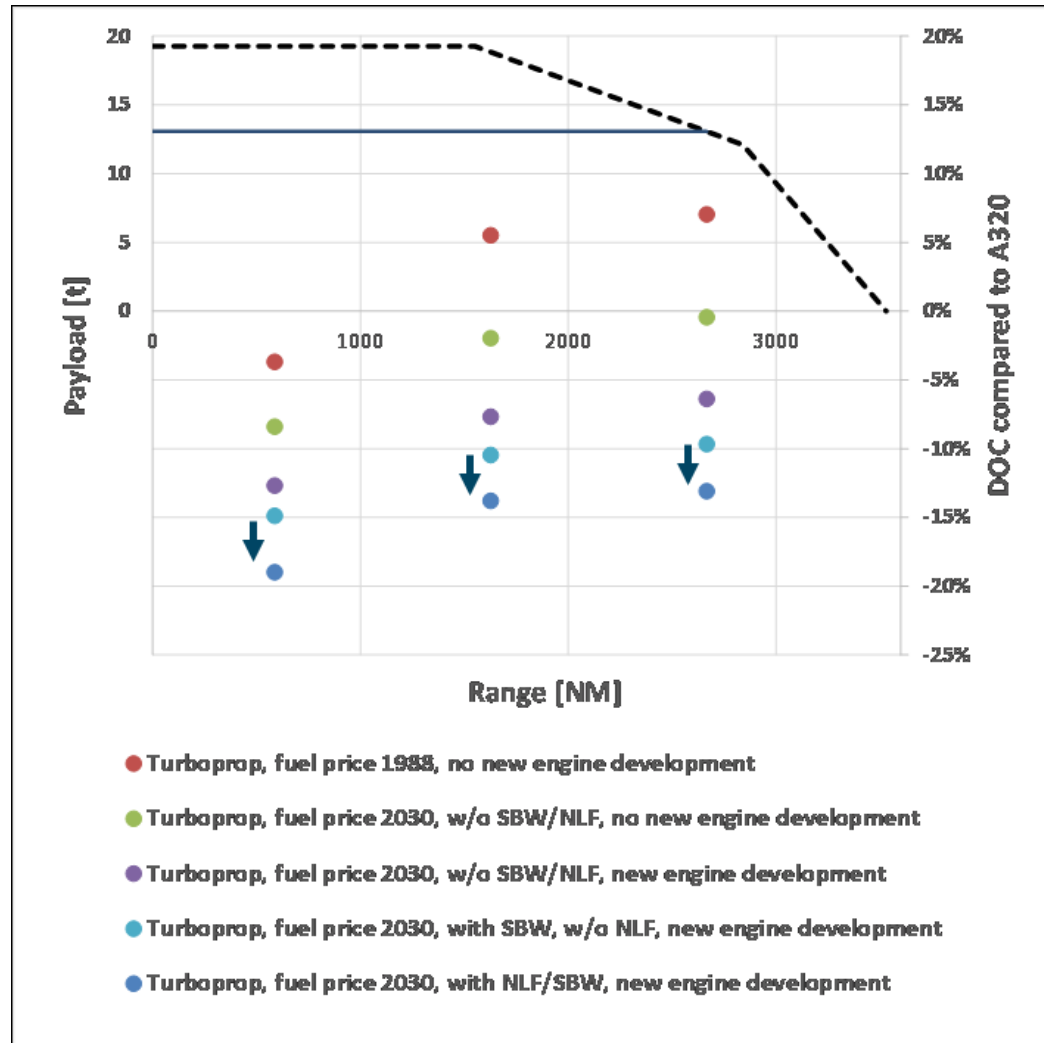

Smart Turboprop: Analysis of the Results

- The average **stage length** of an A320 is quite short (approx. 600 NM)!

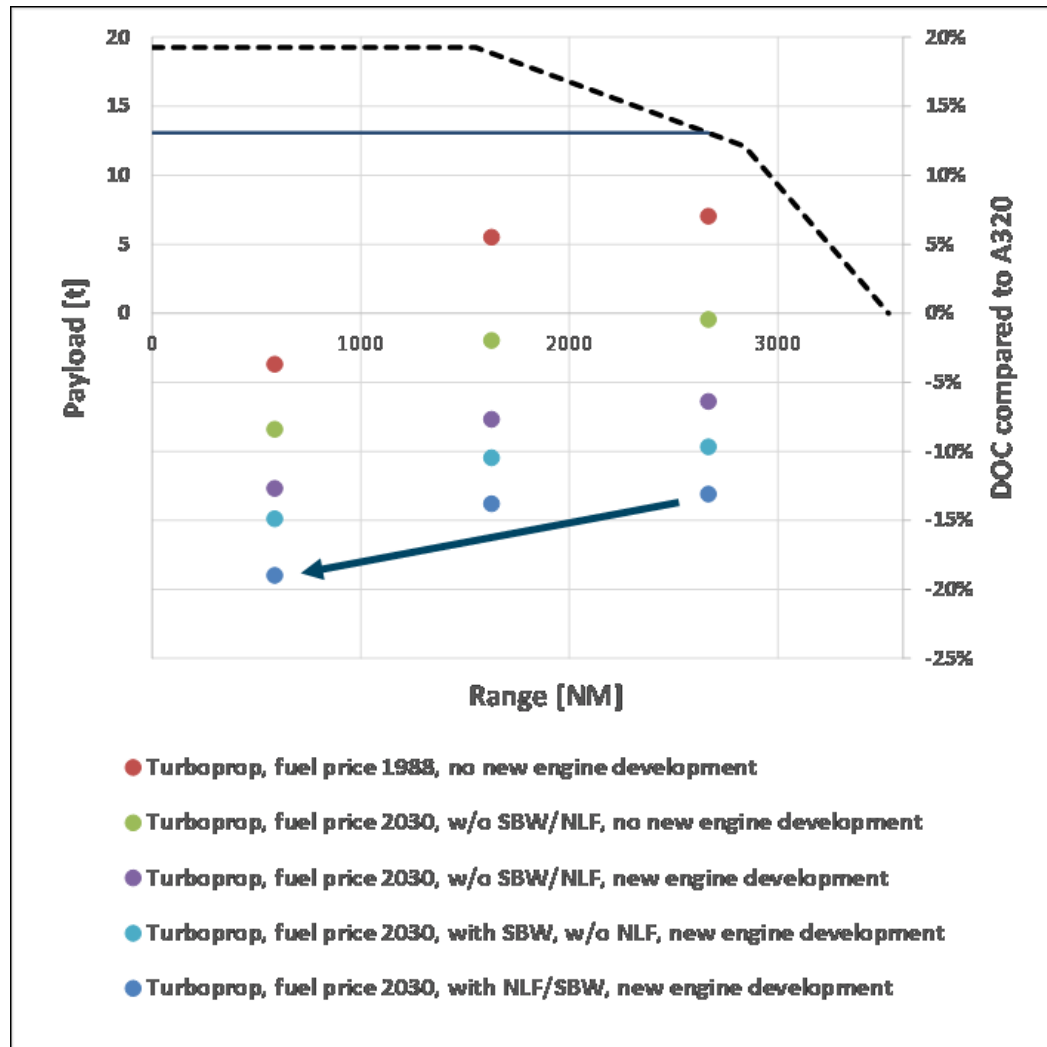

Smart Turboprop and the DLR/Airbus Design Challenge

Design Requirements		Smart Turboprop
PAX	190 all economy @ 30" pitch 135 kg/pax payload capacity for high density layout @ 28" pitch	- 5 % / - 3 % - 25 %
Range	2000 NM (90% of flights within Europe and USA < 500 NM range). Technical means to enable up to 2900 NM range	- 25 %
TOFL	2000 m, SL, MTOW, ISA +15°C	- 12 %
LDGFL	1500 m, SL, MLW, ISA +15°C	- 13 %
Mach	0,79	- 35 %
Initial Climb/ Max. Altitude	FL 350 / FL 410	
Span	Max. 36m or technical means to achieve ICAO class C	0 %
Noise	-5 dB cum. vs. Chapter 4	Achieved:
Fuelburn	-25% versus A320 (CFM) 2009	- 36 %
Emissions	Near zero emissions at gate and during taxi	
CoC	-35% versus A320 (CFM) 2009	≈ - 16 %

Non-Standard Jet Configuration: "Box Wing Aircraft" (BWA)

- **Unconventional Aircraft Configuration**

- Reduction of Induced Drag
- **Different Types** considered
 - Diamond BWA / Biplane BWA
 - Wide body / Slender body

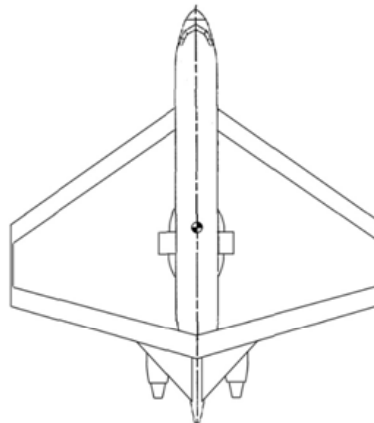
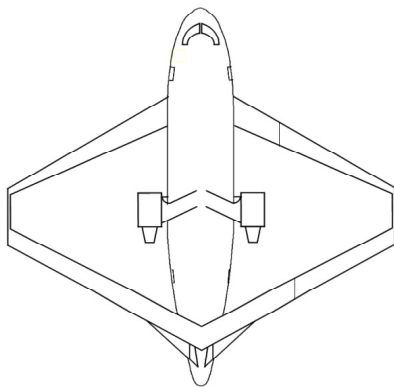

Box Wing Aircraft

- Hand Sketches

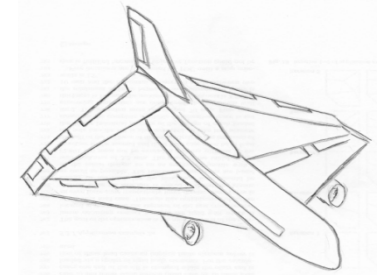
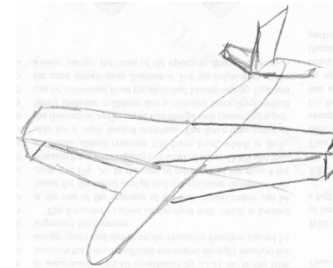
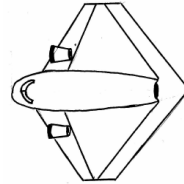

- Creative Methods

- Brainstorming
- Gallery Method



VERHEIRE, E.: Systematic Evaluation of Alternative Box Wing Aircraft Configurations. Bachelor Thesis, HAW Hamburg, 2013

- Modified Morphological Analysis

Morphological Analysis Matrix created after down selection

Stagger	Sweep	Box Wing Vertical Position	Horizontal Stabilizer Position	Vertical Stabilizer Position	Engine Position
=	<<	L – H	Can	Aft	Fuse – aft
–	>>	L – SH	No		Fuse – mid
–	<>		Aft		Wing

Number of Combinations: $3 \cdot 3 \cdot 2 \cdot 3 \cdot 1 \cdot 3 = 162$

BARUA, P; SCHOLZ, D.: Systematic Approach to Analyze, Evaluate and Select Box Wing Aircraft Configurations from Modified Morphological Matrices. TN, HAW Hamburg, 2013

Modified Morphological Analysis:

Successive combination (in „best“ order) followed by immediate down selection => 18

Box Wing Aircraft

Box wing with different wing vertical position

	Low – High Position	Low – Super High Position	Super Low – High Position	Super Low – Super High Position
OpenVSP front view figure				

Example of possible vertical tails

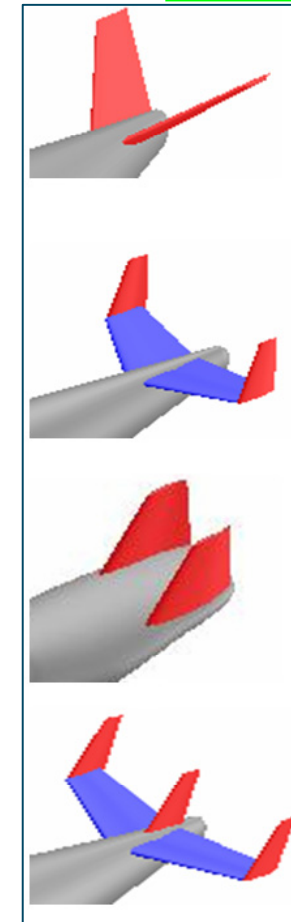

Horizontal tail surface position along the fuselage length

	Canard	No Horizontal tail	Horizontal surface
OpenVSP 3-D figure			

Engine positions for box wing aircraft

	Fuselage Aft	Fuselage Middle	On the wing
OpenVSP 3-D figure			

All possible variations together would lead to 31 104 000 combinations (from Bachelor thesis)

Box Wing Aircraft

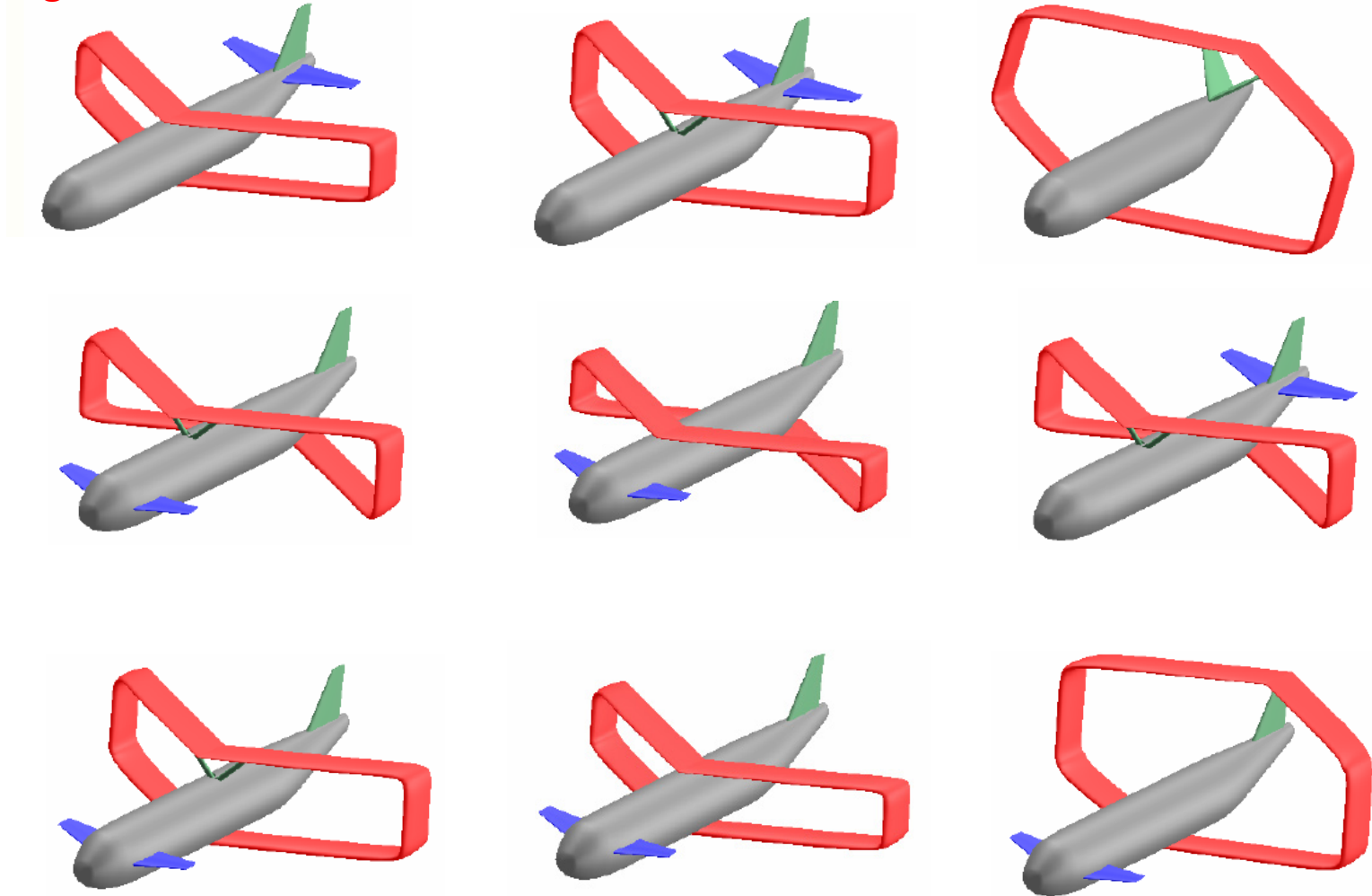

Box Wing Aircraft

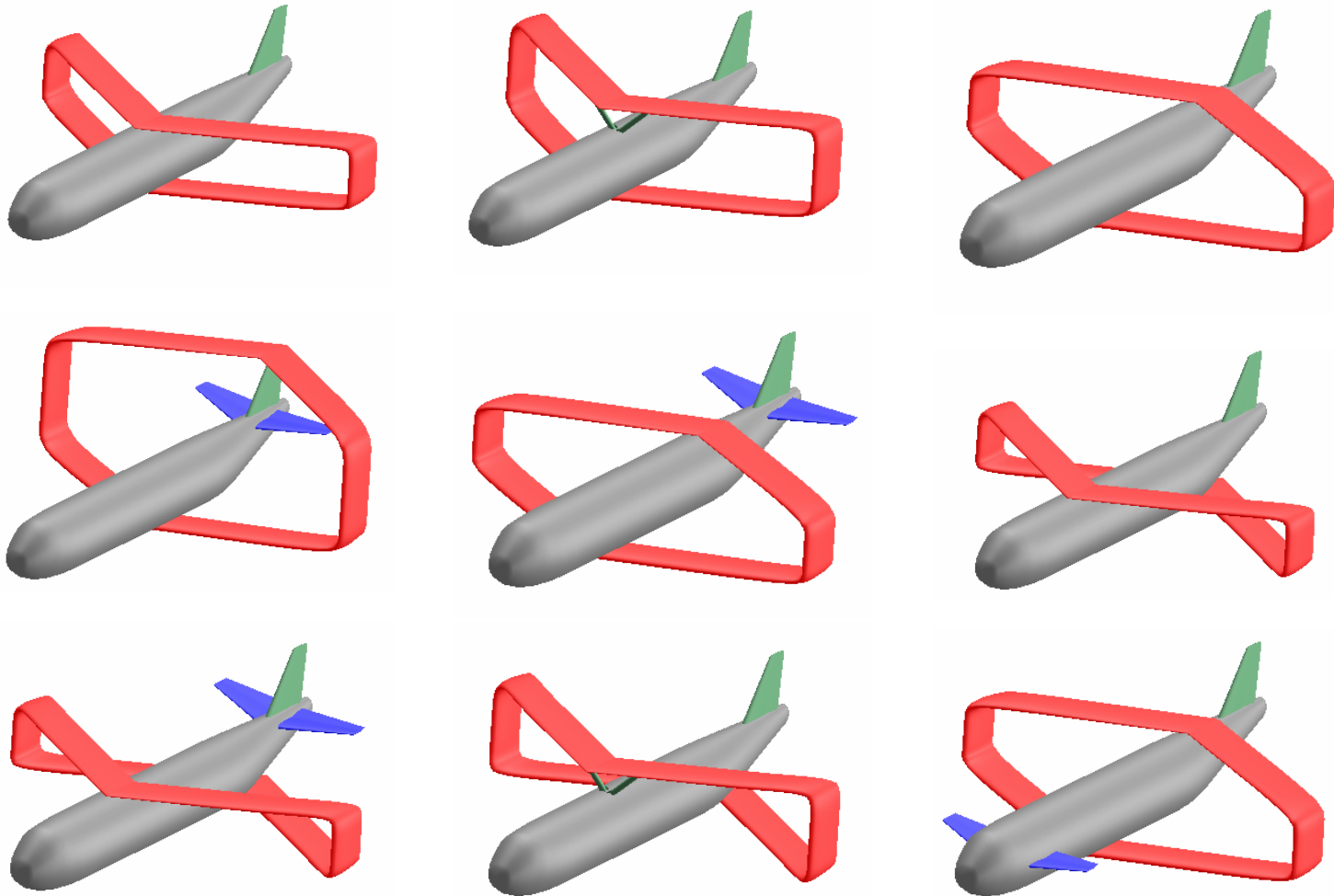

Box Wing Aircraft: General Morphological Analysis

German: „Nutzwertanalyse“ (ZANGEMEISTER): Weighted Sum of Evaluation Points

- Configuration
 - Force Fighting
 - Family Concept
- Drag
 - Zero Lift Drag
 - Induced Drag
- Weight
 - Empty Weight
- Flight Mechanics
 - Longitudinal Static Stability and CG Range
- Operation
 - Ground Handling
- Development
 - Time and Cost
 - Risk

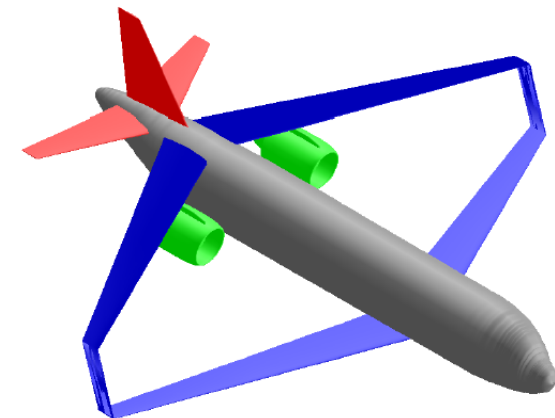
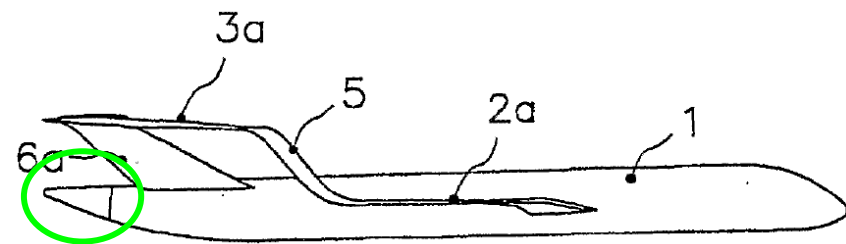

Box Wing Aircraft: General Morphological Analysis: Results

1.

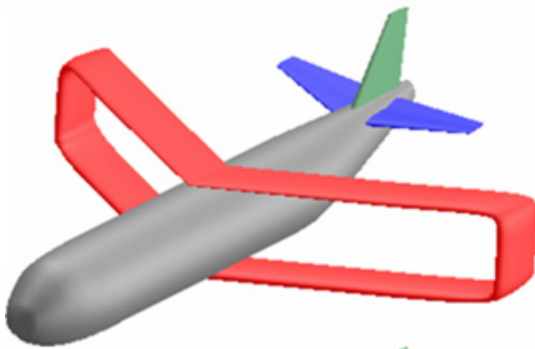

2.

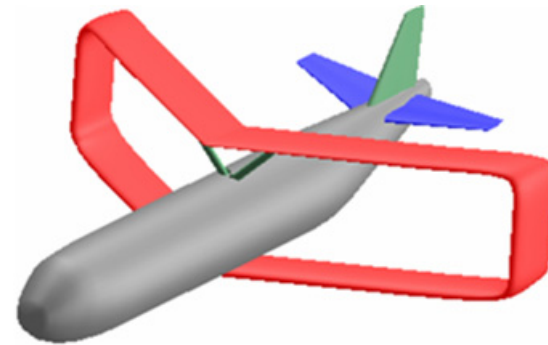

3.

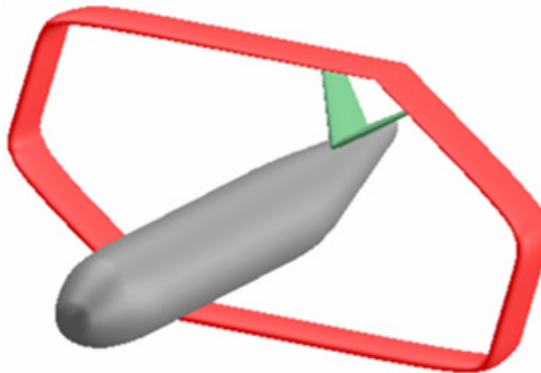

Best unconventional configuration

Box Wing Aircraft: Aerodynamics

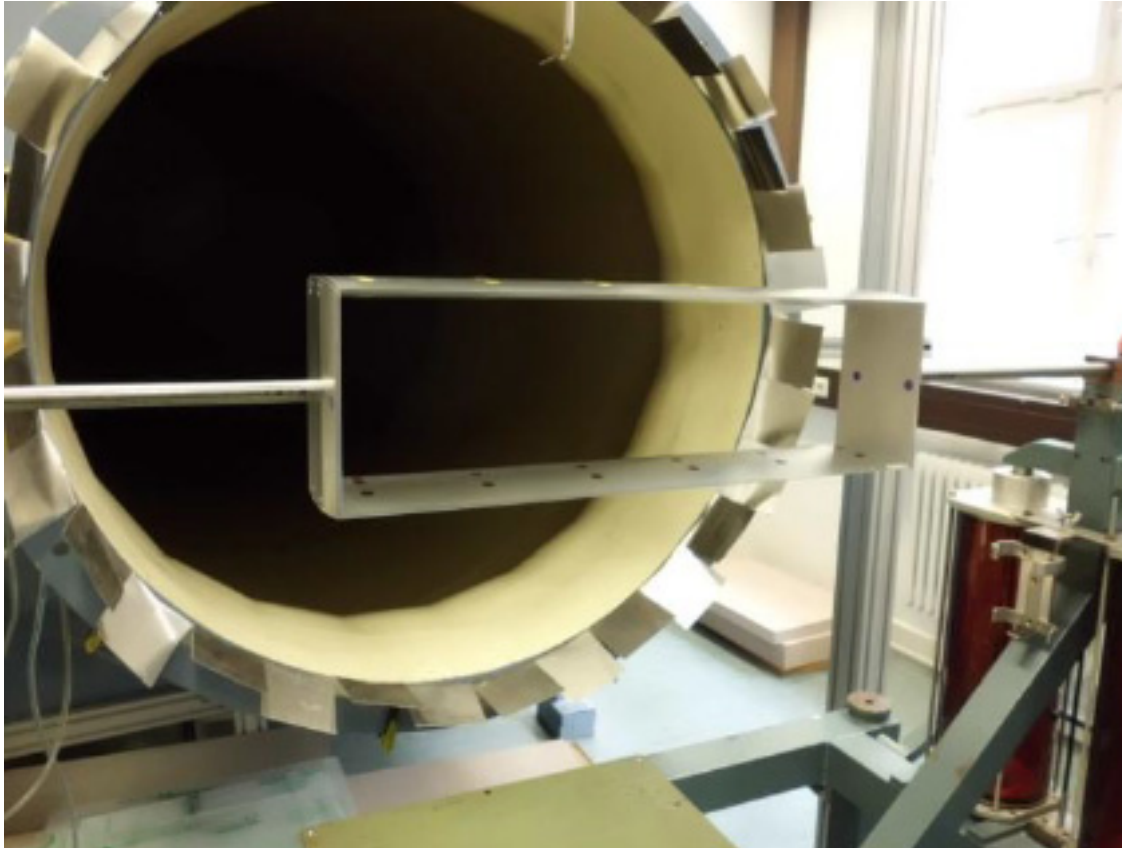

Measurements of induced drag of different box wings in the wind tunnel of HAW Hamburg

The reference wing

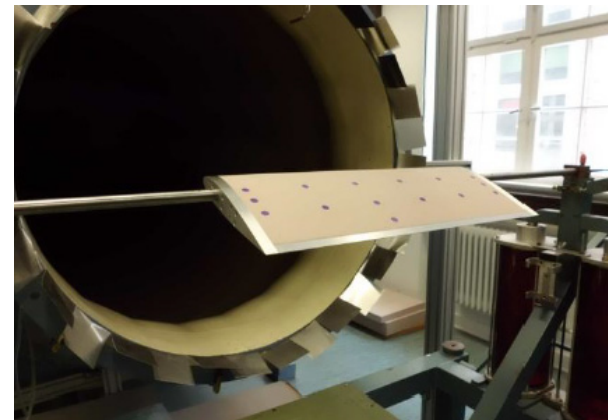

DORENDORF, G.: Vergleich einer Boxwing-Konfiguration mit einem einfachen Tragflügel. Project, HAW Hamburg, 2012

Box Wing Aircraft: Aerodynamics

$$\frac{D_{i,box}}{D_{i,ref}} = \frac{e_{ref}}{e_{box}} = k$$

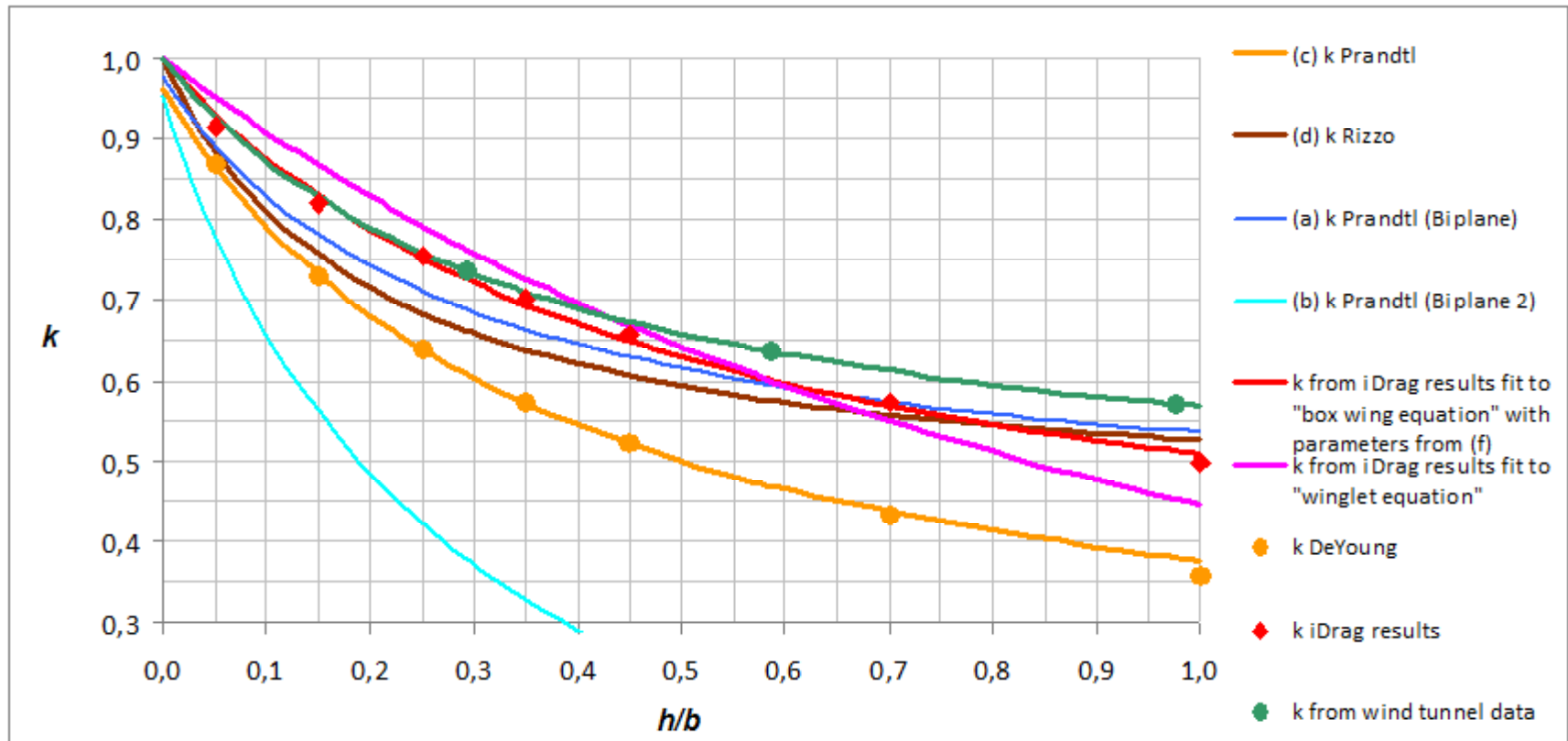

NITA, M.; SCHOLZ, D.: Estimating the Oswald Factor from Basic Aircraft Geometrical Parameters. Berlin, DLRK 2012

Box Wing Aircraft: Glide Ratio

For E_{\max} : $C_{D0} = C_{Di}$??? for Box Wing Aircraft ???

Considering a ratio $h/b = 1$, it yields to $C_{Di,BW}/C_{Di,ref} \approx 0.5$:

- Box Wing flies at reference Aircraft Altitude

$$\frac{E_{\max,BW}}{E_{\max,ref}} = \frac{4}{3} = 1.33$$

- Reference Aircraft flies at Box Wing Altitude

$$\frac{E_{\max,BW}}{E_{\max,ref}} = \frac{3}{2} = 1.5$$

- „Fair“ comparison:

$$\frac{E_{\max,BW}}{E_{\max,ref}} = \sqrt{2} = 1.41$$

Considering a realistic ratio $h/b = 0.25$, it yields to $C_{Di,BW}/C_{Di,ref} \approx 0.75$:

$$\frac{E_{\max,BW}}{E_{\max,ref}} = 1.15$$

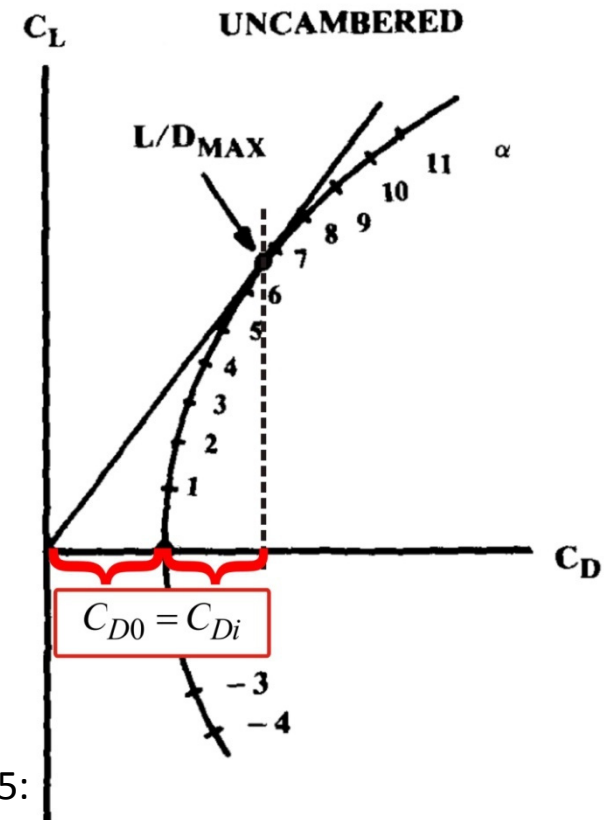

SCHIKTANZ, D.; SCHOLZ, D.:
Maximum Glide Ratio of Box Wing Aircraft –
Fundamental Considerations. Memo, 2012

Glide ratio of a Box Wing Aircraft is 15 % higher than that of the reference aircraft

Box Wing Aircraft: Longitudinal Static Stability

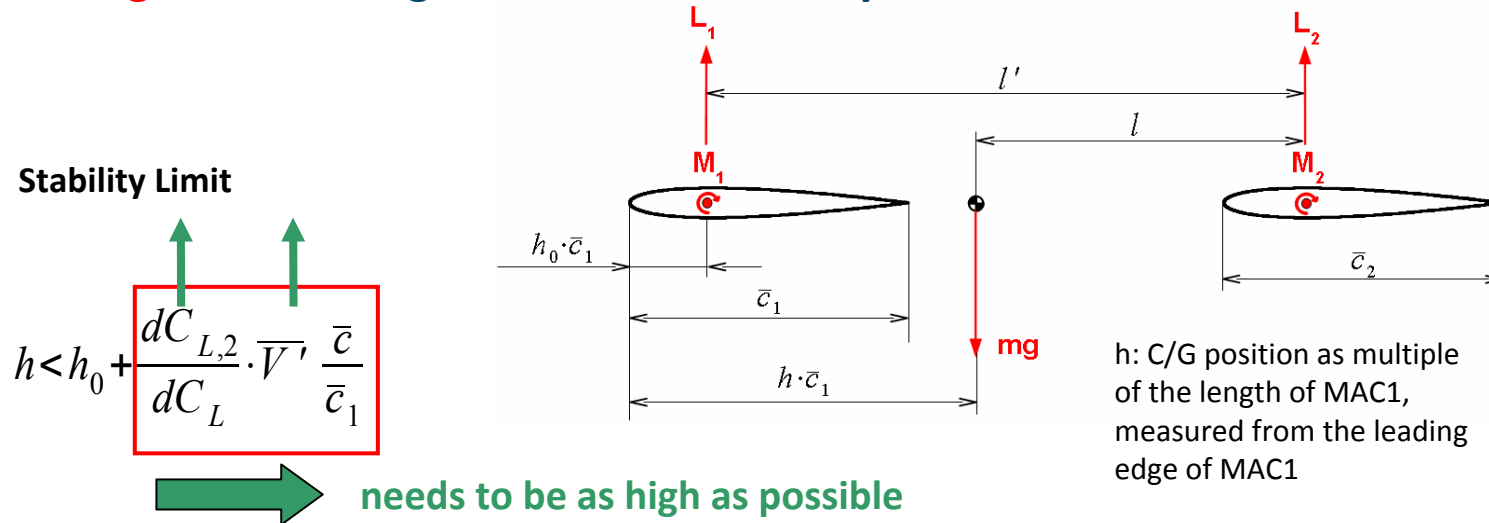

Control Limit



$C_{L,2}$ needs to be low. Thus for a given C_L
 $C_{L,1}$ needs to be increased

Trim Condition



$C_{L,2}$ needs to be lower than $C_{L,1} \Rightarrow C_{L,1} / C_{L,2} > 1$

Forward wing needs higher lift coefficient than aft wing

Munk: drag independent of stagger

SCHIKTANZ, D.; SCHOLZ, D.: The Conflict of Aerodynamic Efficiency and Static Longitudinal Stability of Box Wing Aircraft. Venice, CEAS 2011

Box Wing Aircraft: Aerodynamics

Prandtl (for $h/b = \text{infinity}$):

$$\frac{C_{D,i}}{C_{D,i,min}} = \frac{2(x^2 + 1)}{(x + 1)^2} \quad \text{with} \quad x = \frac{C_{L,1}}{C_{L,2}}$$

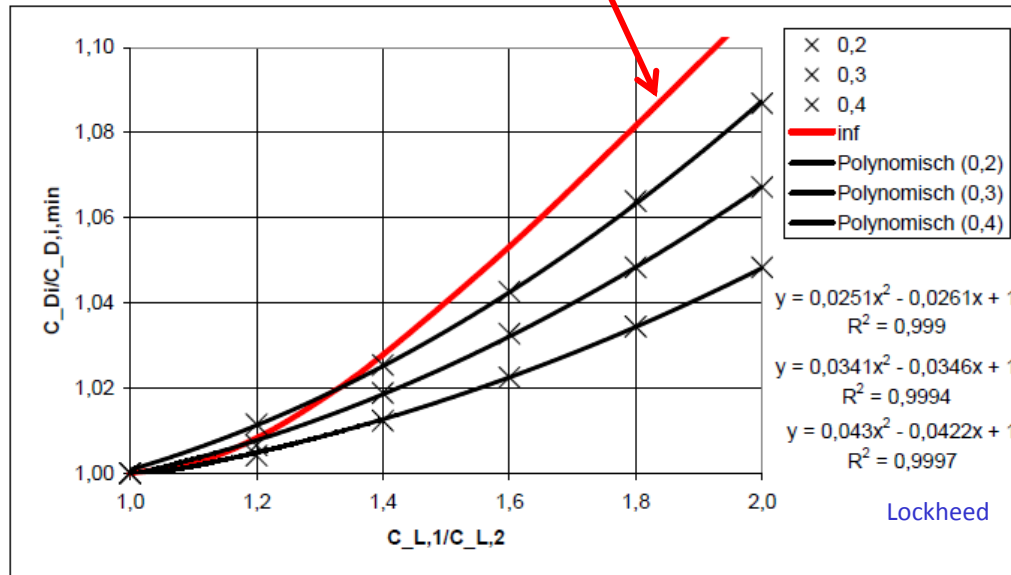

LOCKHEED: Transonic Biplane Concepts.
NACA CR 132462, 1974

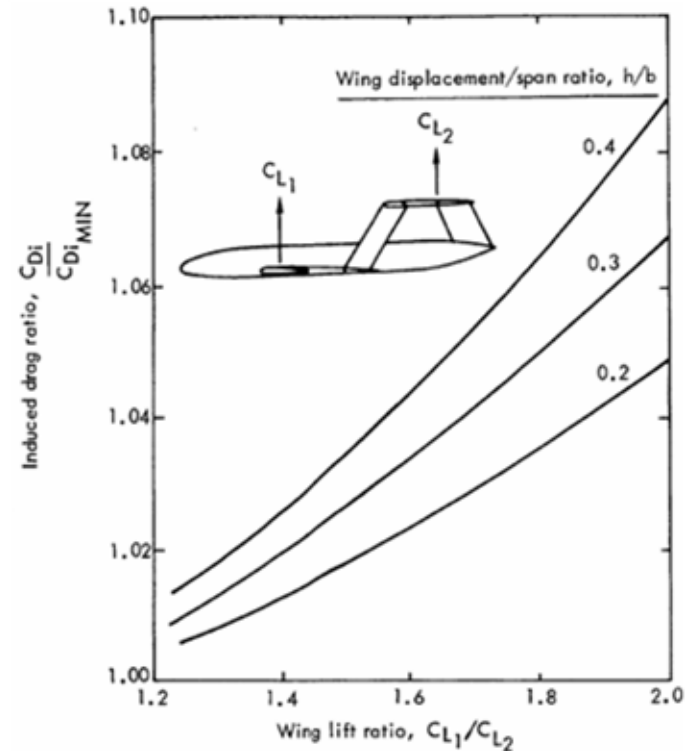

Induced drag increases if lift coefficients are different

CAJA CALLEJA, R.; SCHOLZ, D.: Design Aspects of Passenger
Box Wing Aircraft. Berlin, DLRK 2012

Box Wing Aircraft: Aerodynamics

Sensitivity of induced drag to non-optimum lift distributions (Tornado)

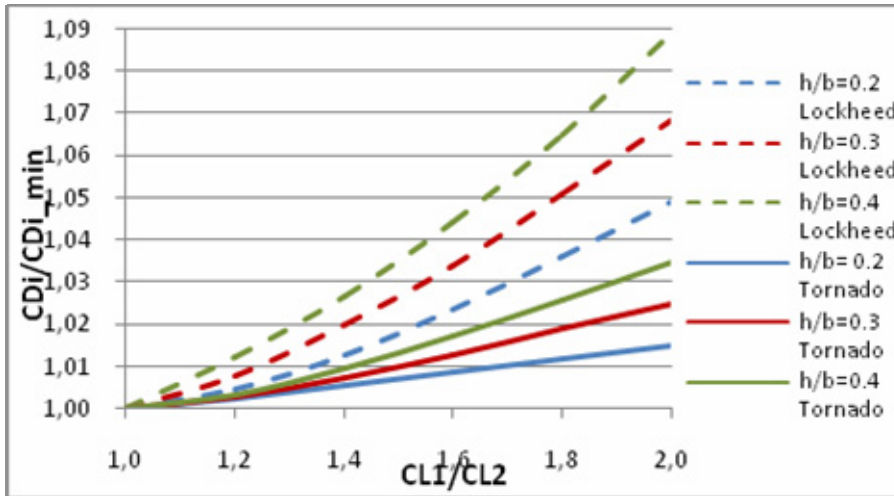

Stagger = 0

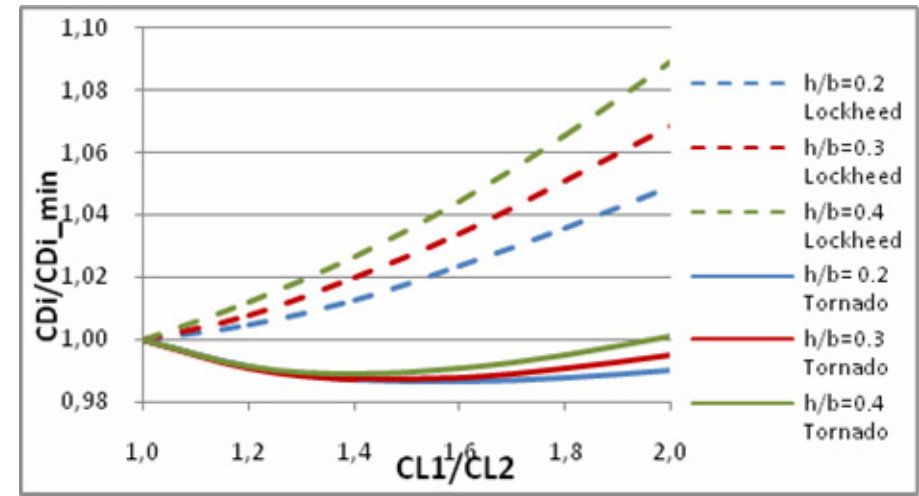
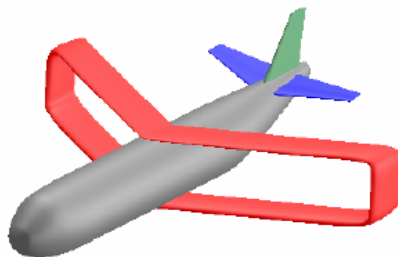

Stagger = -0.5b

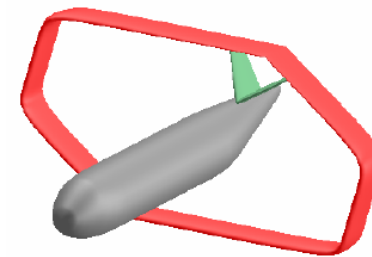

If the low wing is in front => No induced drag increase!

Box Wing Aircraft: Cabin and Fuselage Layout (Wide Body)

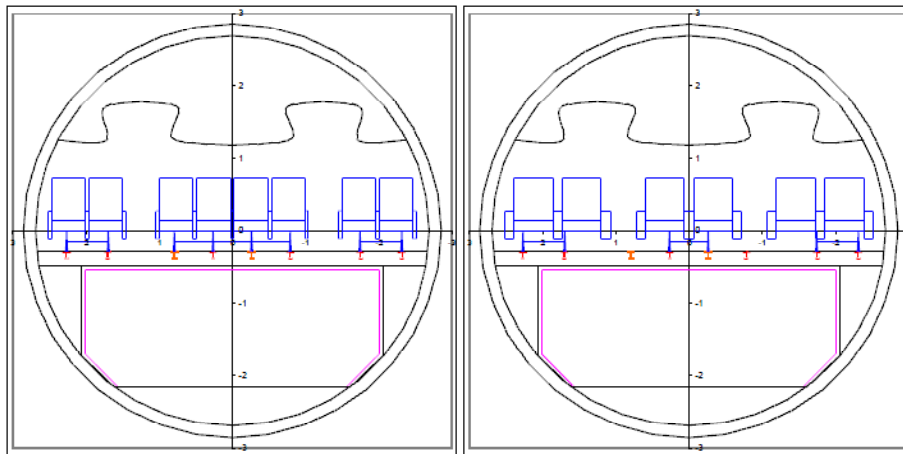

Fuselage cross section for economy class and business class (modelled with PreSto Cabin)

SCHIKTANZ, D.; SCHOLZ, D.: Box Wing Fundamentals – An Aircraft Design Perspective. Bremen, DLRK 2011

SCHIKTANZ, D.: Conceptual Design of a Medium Range Box Wing Aircraft. Master Thesis, 2011

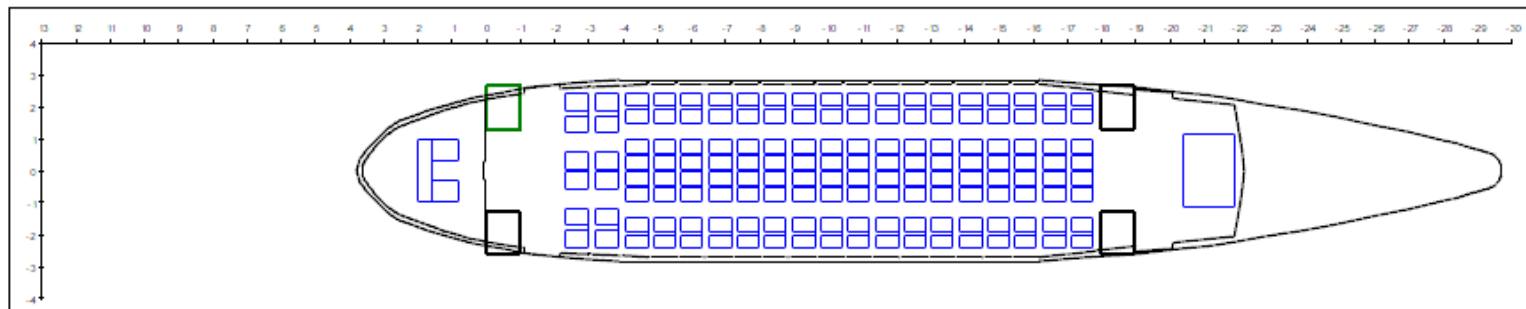

Cabin floor plan of the box wing aircraft (modelled with PreSto Cabin)

Box Wing Aircraft: Design Evolution (Wide Body)

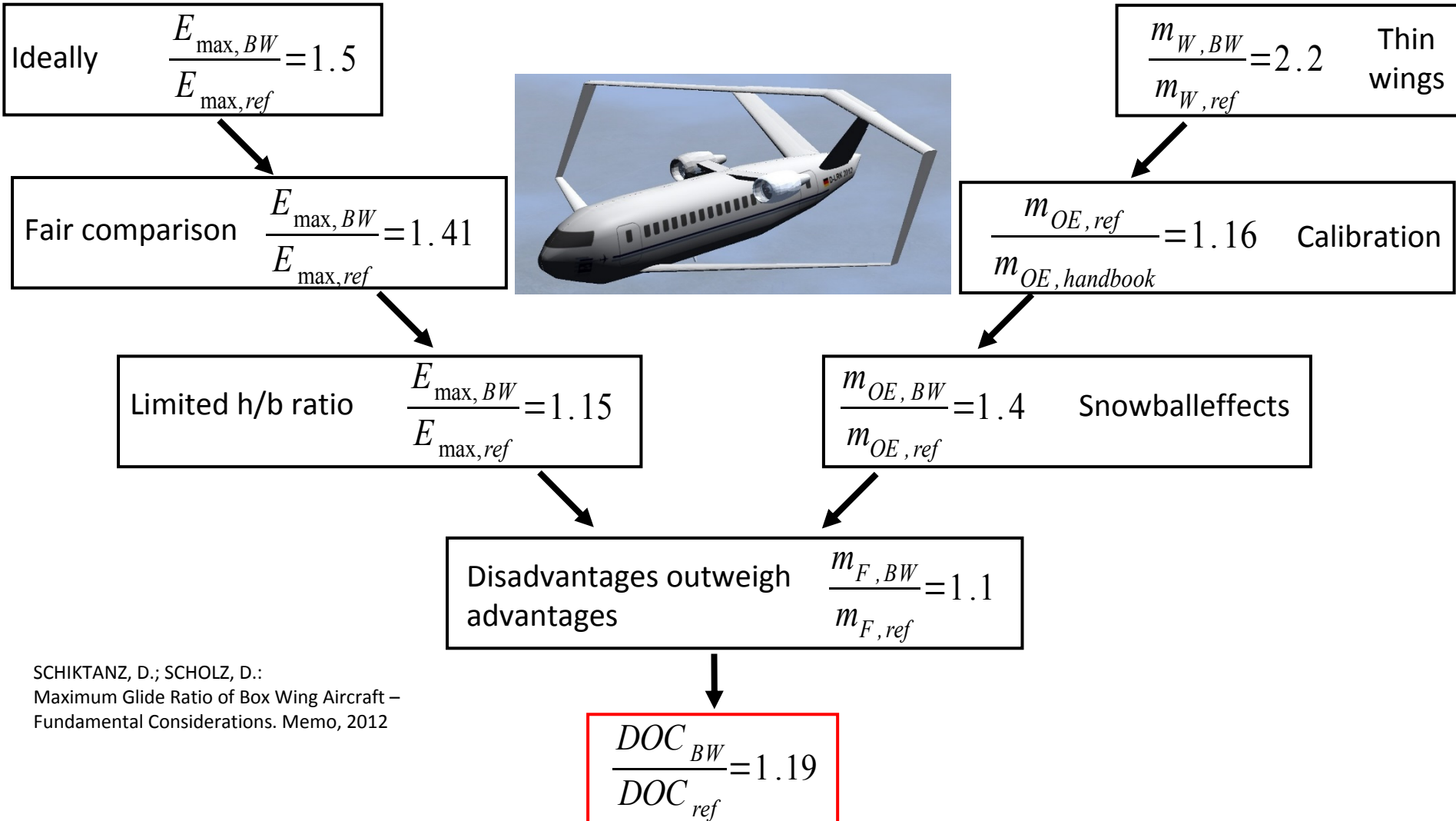

Box Wing Aircraft: Results (Wide Body)

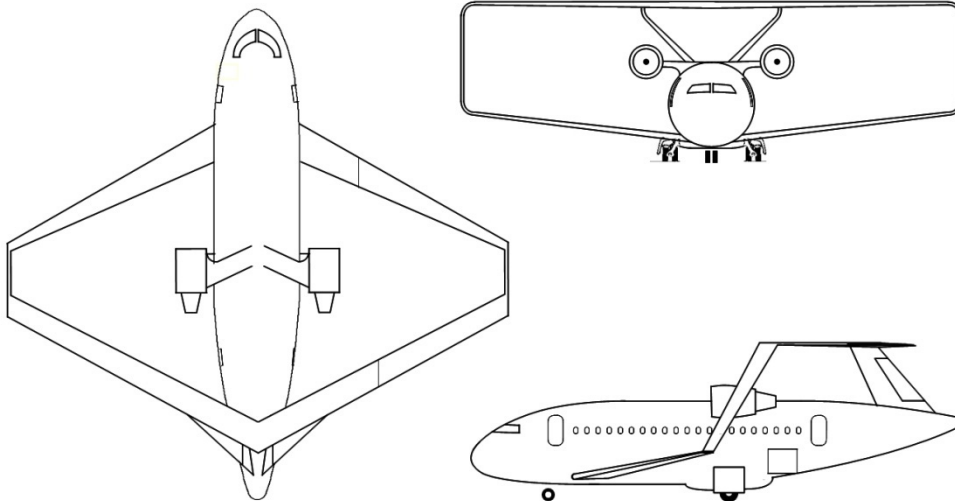

Parameter	Value	Deviation from A320*
Requirements		
m_{MPL}	19256 kg	0 %
R_{MPL}	1510 NM	0 %
M_{CR}	0.76	0 %
$\max(s_{TOFL}, s_{LFL})$	1770 m	0 %
n_{PAX} (1-cl HD)	180	0 %
m_{PAX}	93 kg	0 %
SP	29 in	0 %

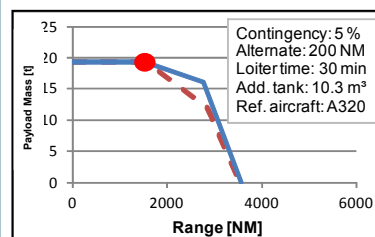
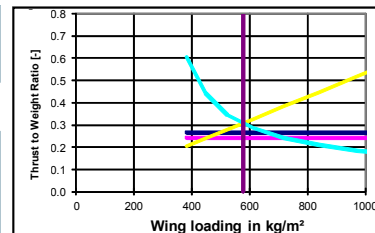

Parameter	Value	Deviation from A320*
Main aircraft parameters		
m_{MTO}	89600 kg	+ 22 %
m_{OE}	55800 kg	+ 35 %
m_F	14500 kg	+ 12 %
S_W	155 m ²	+ 27 %
$b_{W,geo}$	35.9 m	+ 5 %
$A_{W,eff}$	18.9	+ 99 %
E_{max}	19.5	\approx + 11 %
T_{TO}	134 kN	+ 21 %
BPR	6	+ 0 %
SFC	1.62E-5 kg/N/s	- 2 %
h_{ICA}	40700 ft	+ 5 %
s_{TOFL}	1770 m	0 %
s_{LFL}	1450 m	0 %
t_{TA}	25 min	0 %

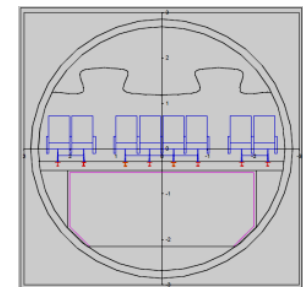

Box Wing Aircraft: Results (Wide Body)



Parameter	Value	Deviation from A320*
DOC mission requirements		
R_{DOC}	755 NM	0 %
$m_{PL,DOC}$	19256 kg	0 %
EIS	2030	-----
C_{fuel}	1.44 USD/kg	0 %
Results		
$m_{F,trip}$	6425 kg	+ 10 %
$U_{a,f}$	2617 h	- 10 %
DOC (AEA)	119 %	+ 19 %

Operating empty mass breakdown

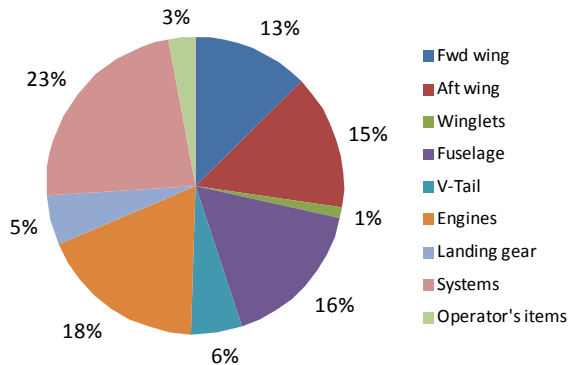

Component drag breakdown

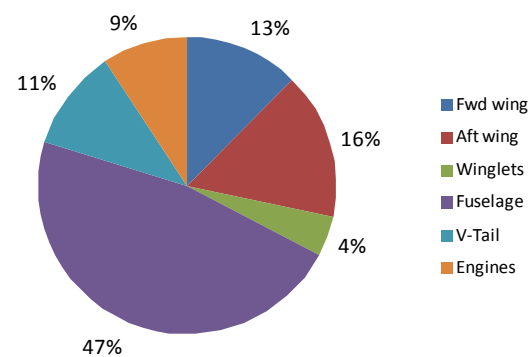

Direct operating cost breakdown

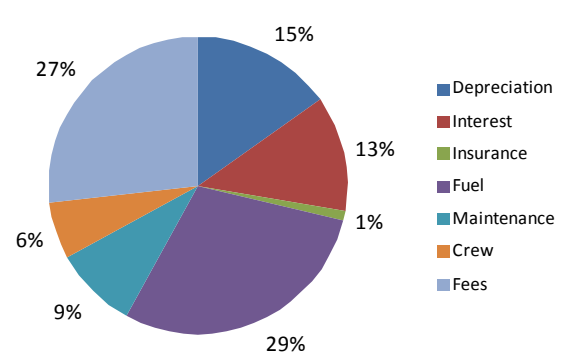

Box Wing Aircraft: Results (Slender Body)

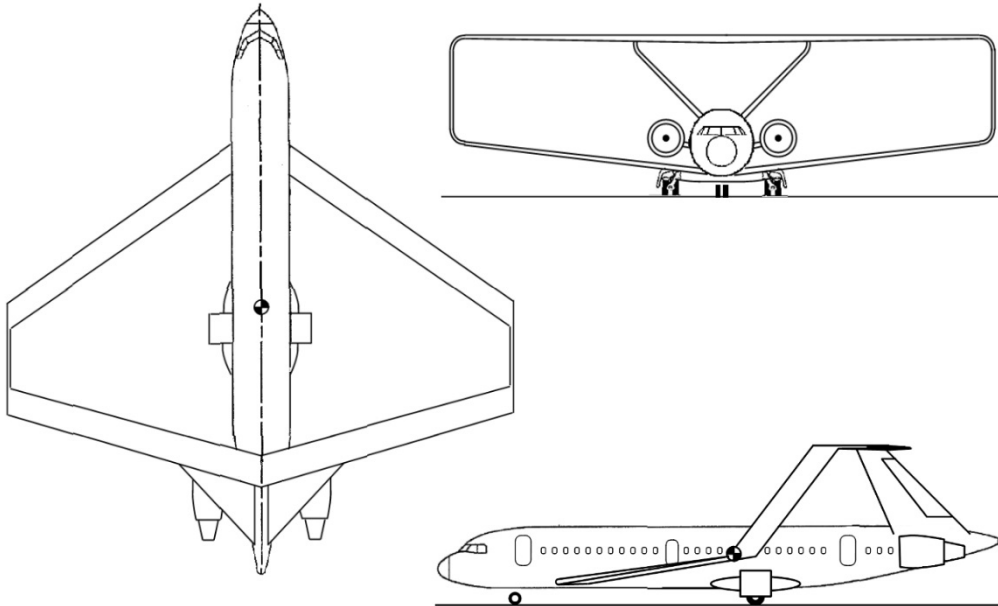

Parameter	Value	Deviation from A320*
Requirements		
m_{MPL}	19256 kg	0 %
R_{MPL}	1510 NM	0 %
M_{CR}	0.76	0 %
$\max(s_{TOFL}, s_{LFL})$	1770 m	0 %
n_{PAX} (1-cl HD)	180	0 %
m_{PAX}	93 kg	0 %
SP	29 in	0 %

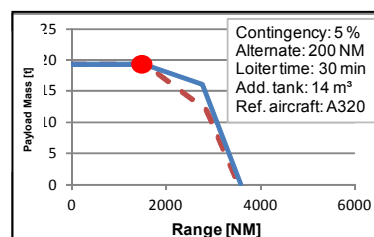
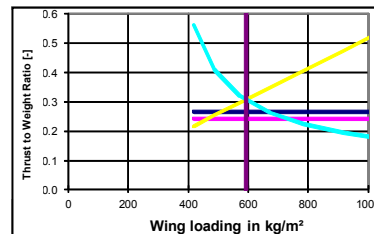

Parameter	Value	Deviation from A320*
Main aircraft parameters		
m_{MTO}	90900 kg	+ 24 %
m_{OE}	57700 kg	+ 40 %
m_F	14000 kg	+ 7 %
S_W	153 m ²	+ 26 %
$b_{W,geo}$	36.0 m	+ 5 %
$A_{W,eff}$	17.0	+ 79 %
E_{max}	21.4	\approx + 21 %
T_{TO}	136 kN	+ 22 %
BPR	6	+ 0 %
SFC	1.62E-5 kg/N/s	- 2 %
h_{ICA}	41900 ft	+ 8 %
s_{TOFL}	1770 m	0 %
s_{LFL}	1450 m	0 %
\hat{t}_{TA}	32 min	0 %

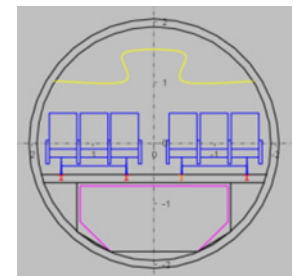

Box Wing Aircraft: Results (Slender Body)

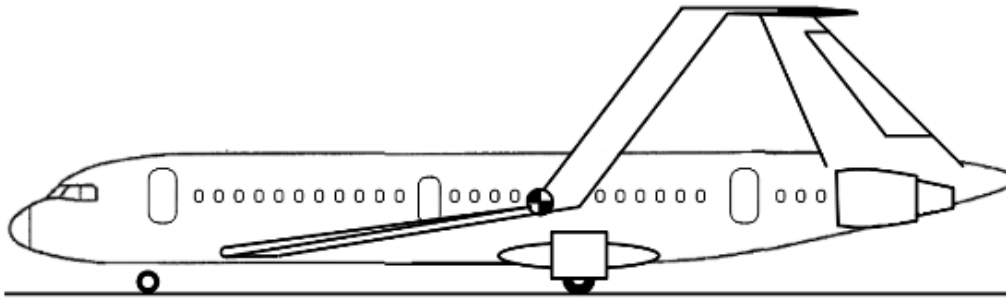

Parameter	Value	Deviation from A320*
DOC mission requirements		
R_{DOC}	755 NM	0 %
$m_{PL,DOC}$	19256 kg	0 %
EIS	2030	-----
C_{fuel}	1.44 USD/kg	0 %
Results		
$m_{F,trip}$	6242 kg	+ 7 %
$U_{a,f}$	2617 h	- 10 %
DOC (AEA)	120 %	+ 20 %

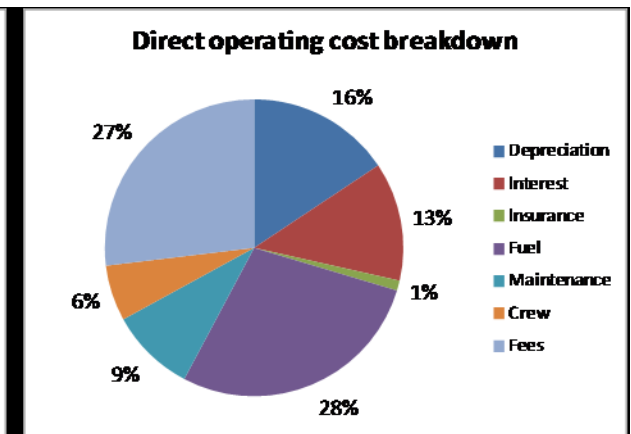
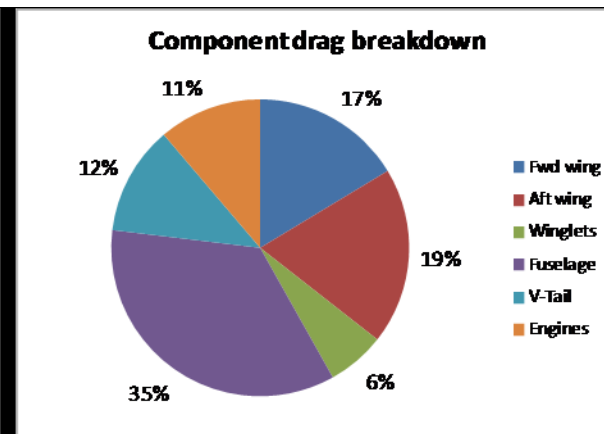
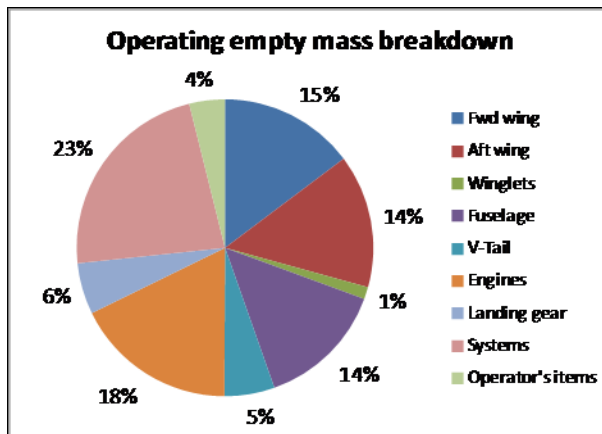

Box Wing Aircraft: Family Concept (Wide Body)

Box Wing General Familiarization

Twin Aisle Family Highlights

Two-class seating

218

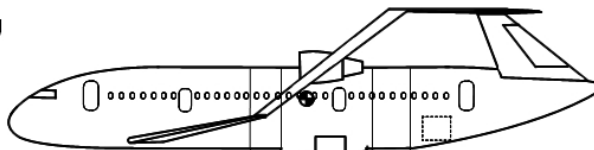

V200
+6 frames

178



V100
+7 frames

148



base

	base	V100	V200
Fuselage Length	33.1 m	37.21 m	41.28 m
Underfloor Volume	34.17 m ³	38.42 m ³	42.62 m ³
Longitudinal distance from AC1 to AC2 (l')	12.50 m	15.50 m	19.57 m
Winglets Sweep (at 25% chord)	28.67°	43.44°	56.12°

AHMED, S.: Family Concepts of Box Wing Aircraft. Memo, 2012

Box Wing Aircraft: Family Concept (Slender Body)

Box Wing General Familiarization

Single Aisle Family Highlights

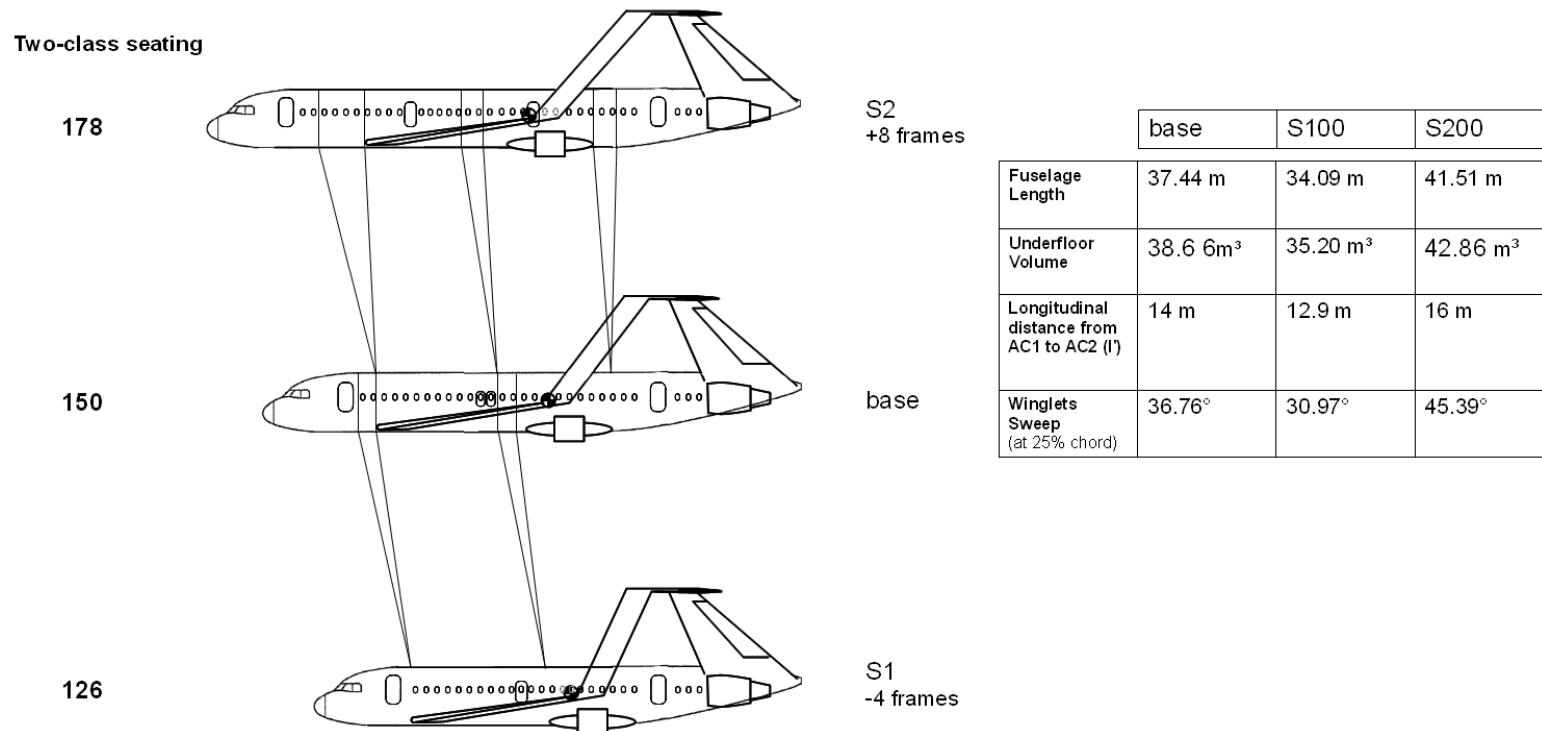

Box Wing Aircraft: Ground Handling

JOHANNING, A.; SCHOLZ, D.: 8.Zwischenbericht.
Verbundprojekt Effizienter Flughafen 2030, 2013

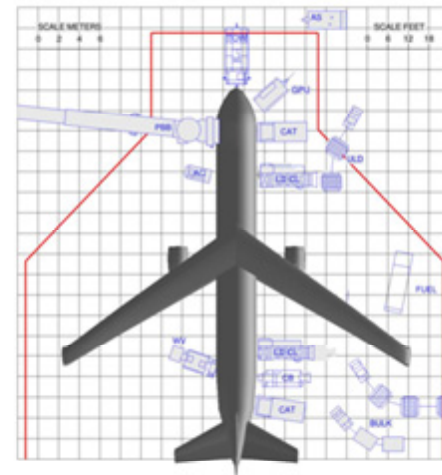
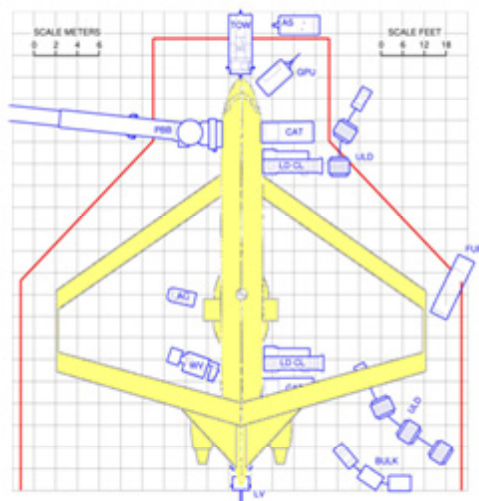
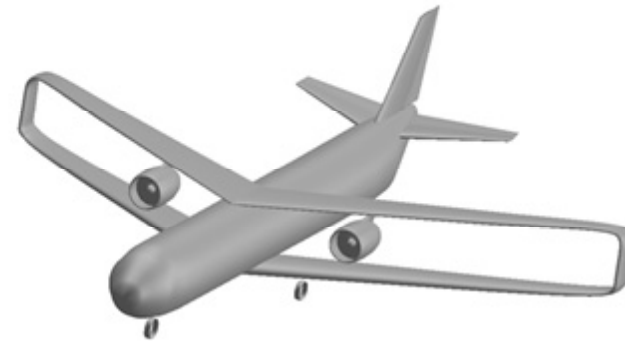
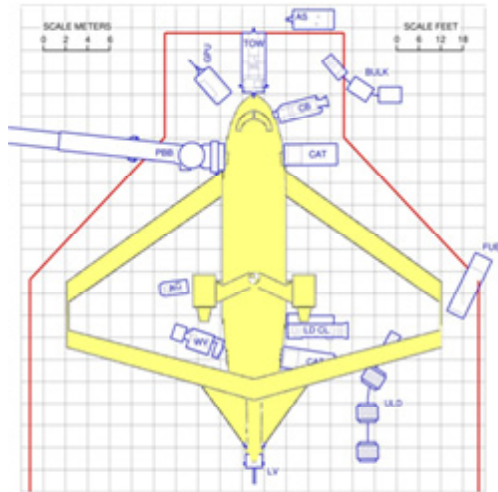

Box Wing Aircraft: Flying Qualities Calculation, Flight Simulation

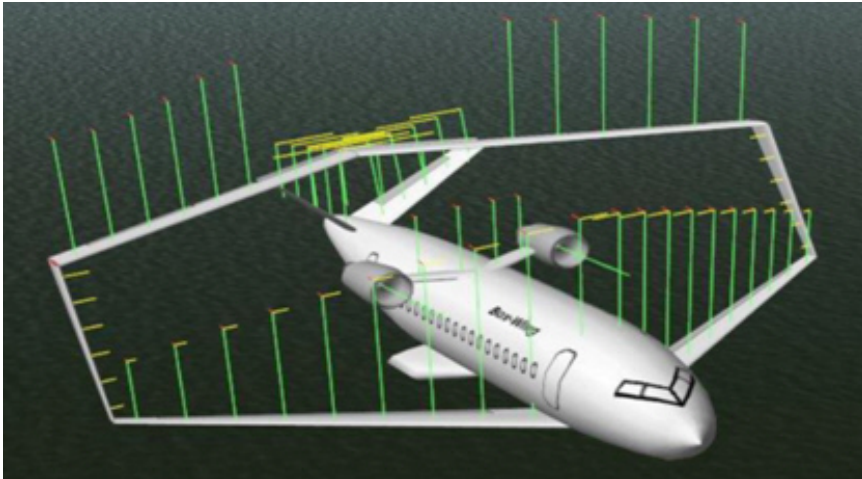

Simulator X-Plane with Aircraft Generator PlaneMaker

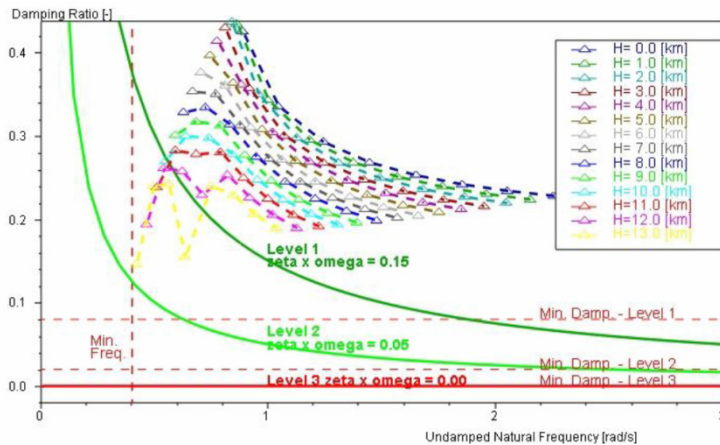

Dutch Roll Mode:

Damping
versus
Frequency

$h = 0 \text{ km} \dots 13 \text{ km}$,
 $V = 100 \text{ m/s} \dots$
 240 m/s



Simulator Flight Gear / Flight Dynamics Model / JSBSim

CAJA CALLEJA, R.; SCHOLZ, D.: Box Wing Flight Dynamics in the Stage of Conceptual Aircraft Design. Berlin, DLRK 2012

CAJA CALLEJA, R.: Flight Dynamics Analysis of a Medium Range Box Wing Aircraft. Master Thesis, 2012

Summary

- Ground handling needs to be robust – it is NOT a financial game changer
- 36 m requirement for max. wing span in Class C drives the design today!
- Standard Jet Configuration, "**The Rebel**":
 - Challenges only requirements (wing span, take-off distance, cruise Mach number), no new technology!
 - Optimized for minimum fuel: => 36 % less fuel consumption, 7% less DOC.
- "**Smart Turboprop**":
 - Efficient engine combined with braced wing and natural laminar flow on wing.
 - Meeting all standard requirements! Optimized for (lower) cruise Mach number.
 - Optimized for minimum DOC: => 36 % less fuel consumption, 17 % less DOC.
- "**Box Wing Aircraft**":
 - This may be the best Box Wing configuration:
 - But nevertheless: No advantage in DOC or fuel burn compared to baseline.

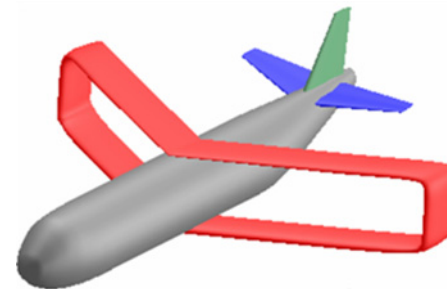

Outlook

Integration of Life Cycle Assessment into Conceptual Aircraft Design

→ Optimization for minimum environmental impact

Contribution of different in- and outputs to the environmental impact of an Airbus A320-200

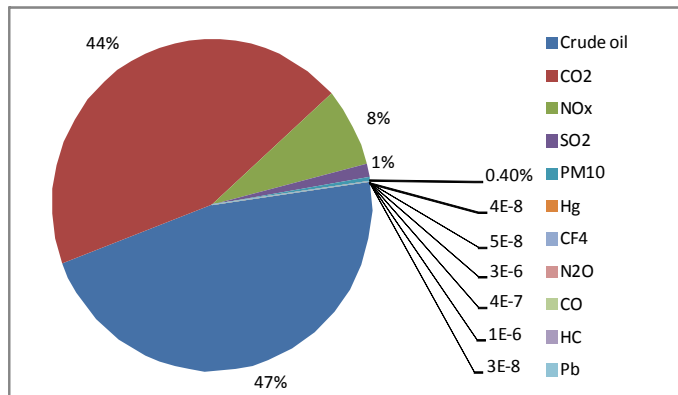

Contribution of the endpoint categories to the environmental impact of an Airbus A320-200

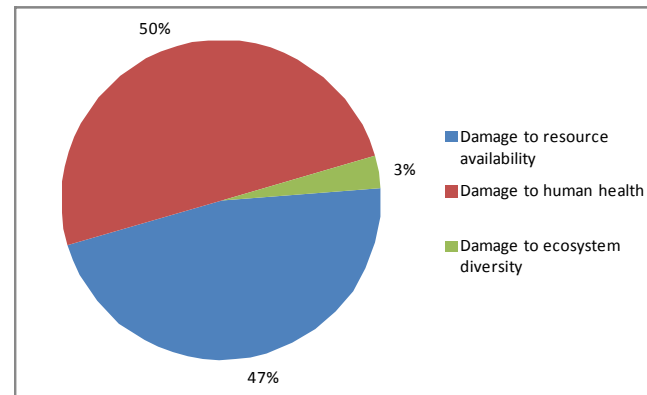

Cooperative PhD Thesis in progress:
*Life-cycle based Multidisciplinary Aircraft
Design Optimization for Future Scenarios*



JOHANNING, A.; SCHOLZ, D.: A first step towards the integration of life cycle assessment into conceptual aircraft design. Stuttgart, DLRK 2013



More information:

<http://Airport2030.ProfScholz.de>

info@ProfScholz.de

References

This presentation is based on AERO's extensive publications and student's contributions as mentioned on the slides. Please see also at <http://Airport2030.ProfScholz.de> and <http://library.ProfScholz.de>

[1] BACHMANN, Justin: In the Battle of the New 737 and A320, Passengers Won't See Much New at All. *Bloomberg Business*. - Available from: <http://www.bloomberg.com/bw/articles/2014-05-20/in-the-battle-of-the-new-737-and-a320-passengers-wont-see-much-new-at-all>

[2] WARWICK, Graham:
Airbus, Snecma Tackle Open-Rotor Integration. *Aviation Week & Space Technology*. 2014-03-31. - Available from: <http://aviationweek.com/equipment-technology/airbus-snecma-tackle-open-rotor-integration>

[3] INTERNATIONAL CIVIL AVIATION ORGANIZATION (ICAO): *Annex 14 to the Convention on International Civil Aviation : Aerodromes, Volume 1, Aerodrome Design and Operations*. ICAO, July 2013. - Available from: <http://www.bazl.admin.ch/experten/00002/index.html>

The method for aircraft optimization is described in Chapter 6 of:

[4] NIȚĂ, Mihaela Florentina: *Contributions to Aircraft Preliminary Design and Optimization*. München : Verlag Dr. Hut, 2013. – ISBN 978-3-8439-1163-4, Dissertation, Download: <http://OPerA.ProfScholz.de>

The "Smart Turboprop" is optimized with an extension to OPerA, called PrOPerA by Andreas Johanning.

[5] NITA, Mihaela; SCHOLZ, Dieter: Estimating the Oswald Factor from Basic Aircraft Geometrical Parameters. In: *Publikationen zum DLRK 2012 (Deutscher Luft- und Raumfahrtkongress, Berlin, 10. - 12. September 2012)*. - URN: urn:nbn:de:101:1-201212176728. DocumentID: 281424. Download: <http://OPerA.ProfScholz.de>

[6] WUTTKE, Thomas: *Airport Compatibility of Medium Range Aircraft with Large Wing Span*. Hamburg : Maxkon., 2014. – Report written as part of <http://Airport2030.ProfScholz.de>

[7] HEPERLE, M.: *MDO of Forward Swept Wings : Presentation at KATnet II Workshop*. Braunschweig, 28. - 29. January 2008. - Available from: http://www.mh-aerotools.de/company/paper_12/KATnet%20-%20Forward%20Swept%20Wings%20-%20DLR-AS%20-%20Hepperle.pdf

Appendix

Parameter	Explanation	Comments
Requirements		
m_{MPL}	Maximum payload [kg]	---
R_{MPL}	Maximum range [kg] (with maximum payload)	---
M_{CR}	Cruise Mach number	---
$\max(s_{TOFL}, s_{LFL})$	Maximum take-off and landing field length [m]	Requirement for the maximum allowable take-off and landing field length
n_{PAX} (1-cl HD)	Number of passengers	one class, high density layout
m_{PAX}	Passenger mass [kg]	Mass of person, carry on baggage, and checked in baggage
SP	Seat pitch [in]	Seat pitch for the one class high-density layout

- Most of the given values are rounded
- The given deviation refers to the real values and not to the rounded values

Appendix

Parameter	Explanation	Comments
Main aircraft parameters		
m_{MTO}	Maximum take-off mass [kg]	---
m_{OE}	Operating empty mass [kg]	---
m_F	Fuel mass [kg]	For required payload and range combination
S_W	Wing area [m ²]	---
$b_{W,geo}$	Geometrical span [m]	---
$A_{W,eff}$	Effective aspect ratio [-]	---
E_{max}	Maximum glide ratio [-]	---
T_{TO}	Take-off thrust for each engine [N]	---
$P_{eq,ssl}$	Equivalent take-off power at static sea level [kW]	---
BPR	Bypass-Ratio [-]	---
d_{prop}	Propeller diameter [m]	---
η_{prop}	Propeller efficiency [%]	---
SFC	Thrust specific fuel consumption [kg/N/s]	---
$PSFC$	Power specific fuel consumption [kg/W/s]	---
h_{ICA}	Initial cruise altitude [m]	---
S_{TOFL}	Take-off field length [m]	---
S_{LFL}	Landing field length [m]	---
t_{TA}	Turnaround time [min]	---

Appendix

Parameter	Explanation	Comments
DOC mission requirements		
R_{DOC}	Range for the DOC calculation [NM]	---
$m_{\text{PL,DOC}}$	Payload mass for the DOC calculation [kg]	---
EIS	Entry into Service	---
c_{fuel}	Fuel cost [USD/kg]	Fuel costs are estimated for the entry into service
Results		
$m_{\text{F,trip}}$	Fuel mass (for the DOC range) [kg]	----
$U_{\text{a,f}}$	Utilization [h]	Product of the number of flights per year and the duration of the flight on the DOC-range
DOC (AEA)	Direct Operating Costs	DOC calculated using the method of the Association of European Airlines

Appendix

Additional Parameters – Standard Jet Configuration: "The Rebel"

Parameter	Explanation	Value
Cabin		
w_{aisle}	Aisle width	8 in
w_{seat}	Seat width	17 in
w_{armrest}	Armrest width	1.6 in
$s_{\text{clearance}}$	Sidewall clearance	0.5 in
Wing		
φ_{25}	Wing sweep at 25 % chord	10°
λ	Wing taper ratio	0.25
Vertical tail		
S_V	Vertical tail area	15.8 m ²
$\varphi_{25,V}$	Vertical tail sweep at 25 % chord	30°
λ_V	Vertical tail taper ratio	0.34
Horizontal tail		
S_H	Horizontal tail area	5.7 m ²
$\varphi_{25,H}$	Horizontal tail sweep at 25 % chord	13°
λ_H	Horizontal tail taper ratio	0.32
DOC		
$k_{\text{delivery,OE}}$	Delivery price per kg m_{OE}	1602 USD/kg

Appendix

Additional Parameters – Standard Jet Configuration: "The Rebel"

Parameter	Explanation	Value
Zero lift & wave drag		
$C_{D,0}$	Zero lift drag	221 drag counts
$C_{D,W}$	Wave drag	10 drag counts
Induced drag		
a_e	---	-0.00152
b_e	---	10.82
c_e	---	1
M_{comp}	Highest Mach number without compressibility effects	0.3
Q	---	1.08
P	---	0.0088
$A_{W,eff}$	Effective aspect ratio of the wing	34.8
cf_e	Correction factor for Oswald factor	1.17

$$e = \frac{k_{e,M}}{Q + P \cdot \pi \cdot A_{W,eff}} \quad k_{e,M} = a_e \cdot \left(\frac{M}{M_{comp}} - 1 \right)^{b_e} + c_e$$

NITA, M.; SCHOLZ, D.: Estimating the Oswald Factor from Basic Aircraft Geometrical Parameters. Berlin, DLRK 2012

Appendix

Additional Parameters – Smart Turboprop

Parameter	Explanation	Value
Cabin		
w_{aisle}	Aisle width	20 in
w_{seat}	Seat width	20 in
w_{armrest}	Armrest width	2 in
$s_{\text{clearance}}$	Sidewall clearance	0.6 in
Wing		
φ_{25}	Wing sweep at 25 % chord	6°
λ	Wing taper ratio	0.20
Vertical tail		
S_V	Vertical tail area	19.3 m ²
$\varphi_{25,V}$	Vertical tail sweep at 25 % chord	28°
λ_V	Vertical tail taper ratio	0.69
Horizontal tail		
S_H	Horizontal tail area	12.4 m ²
$\varphi_{25,H}$	Horizontal tail sweep at 25 % chord	9°
λ_H	Horizontal tail taper ratio	0.25
DOC		
$k_{\text{delivery,OE}}$	Delivery price per kg m_{OE}	1602 USD/kg

Appendix

Additional Parameters – Smart Turboprop

Parameter	Explanation	Value
Zero lift & wave drag		
$C_{D,0}$	Zero lift drag	314 drag counts
$C_{D,W}$	Wave drag	0 drag counts
Induced drag		
a_e	---	-0.00152
b_e	---	10.82
c_e	---	1
M_{comp}	Highest Mach number without compressibility effects	0.3
Q	---	1.08
P	---	0.0119
$A_{W,eff}$	Effective aspect ratio of the wing	14.9
cf_e	Correction factor for Oswald factor	1.56

$$e = \frac{k_{e,M}}{Q + P \cdot \pi \cdot A_{W,eff}} \quad k_{e,M} = a_e \cdot \left(\frac{M}{M_{comp}} - 1 \right)^{b_e} + c_e$$

NITA, M.; SCHOLZ, D.: Estimating the Oswald Factor from Basic Aircraft Geometrical Parameters. Berlin, DLRK 2012

Appendix

Additional Parameters – Box Wing Aircraft (Wide Body)

Parameter	Explanation	Value
Cabin		
w_{aisle}	Aisle width	20 in
w_{seat}	Seat width	20 in
w_{armrest}	Armrest width	2 in
$s_{\text{clearance}}$	Sidewall clearance	0.6 in
Wing		
$\varphi_{25,FW}$	Forward wing sweep at 25 % chord	29°
λ_{FW}	Forward wing taper ratio	0.24
$\varphi_{25,AW}$	Aft wing sweep at 25 % chord	-28°
λ_{AW}	Aft wing taper ratio	0.80
V-tail		
S_V	V-tail area	25 m ²
$\varphi_{25,V}$	V-tail sweep at 25 % chord	-30°
λ_V	V-tail taper ratio	0.50
DOC		
$k_{\text{delivery,OE}}$	Delivery price per kg m_{OE}	1602 USD/kg

Appendix

Additional Parameters – Box Wing Aircraft (Wide Body)

Parameter	Explanation	Value
Zero lift & wave drag		
$C_{D,0}$	Zero lift drag	179 drag counts
$C_{D,W}$	Wave drag	10 drag counts
Induced drag		
e_{ref}	---	0.85
k_1	---	1.04
k_2	---	0.57
k_3	---	1.04
k_4	---	2.13
h/b	---	0.22

$$e_{box} = e_{ref} \cdot \frac{e_{NP}}{e}$$

$$\frac{e_{NP}}{e} = \frac{k_3 + k_4 \cdot \frac{h}{b}}{k_1 + k_2 \cdot \frac{h}{b}}$$

NITA, M.; SCHOLZ, D.: Estimating the Oswald Factor from Basic Aircraft Geometrical Parameters. Berlin, DLRK 2012

Appendix

Additional Parameters – Box Wing Aircraft (Slender Body)

Parameter	Explanation	Value
Cabin		
w_{aisle}	Aisle width	20 in
w_{seat}	Seat width	20 in
w_{armrest}	Armrest width	2 in
$s_{\text{clearance}}$	Sidewall clearance	0.6 in
Wing		
$\varphi_{25,FW}$	Forward wing sweep at 25 % chord	35°
λ_{FW}	Forward wing taper ratio	0.9
$\varphi_{25,AW}$	Aft wing sweep at 25 % chord	-15°
λ_{AW}	Aft wing taper ratio	0.9
V-tail		
S_V	V-tail area	36 m ²
$\varphi_{25,V}$	V-tail sweep at 25 % chord	-37°
λ_V	V-tail taper ratio	0.41
DOC		
$k_{\text{delivery,OE}}$	Delivery price per kg m_{OE}	1602 USD/kg

Appendix

Additional Parameters – Box Wing Aircraft (Slender Body)

Parameter	Explanation	Value
Zero lift & wave drag		
$C_{D,0}$	Zero lift drag	154 drag counts
$C_{D,W}$	Wave drag	10 drag counts
Induced drag		
e_{ref}	---	0.85
k_1	---	1.04
k_2	---	0.57
k_3	---	1.04
k_4	---	2.13
h/b	---	0.25

$$e_{box} = e_{ref} \cdot \frac{e_{NP}}{e}$$

$$\frac{e_{NP}}{e} = \frac{k_3 + k_4 \cdot \frac{h}{b}}{k_1 + k_2 \cdot \frac{h}{b}}$$

NITA, M.; SCHOLZ, D.: Estimating the Oswald Factor from Basic Aircraft Geometrical Parameters. Berlin, DLRK 2012

Appendix

Additional Parameters – Box Wing Aircraft (Biplane)

Elena García Llorente:
Conceptual Design Optimization of Passenger Box Wing Aircraft in Biplane Layout.
Master Thesis. Hamburg University of Applied Sciences, 2014. – <http://library.ProfScholz.de>